



DSE Genset®



DEEP SEA ELECTRONICS PLC

DSE8610 MKII Operator Manual

Document Number: 057-254

Author: Mark Graham



Deep Sea Electronics Plc
Highfield House
Hunmanby
North Yorkshire
YO14 0PH
ENGLAND

Sales Tel: +44 (0) 1723 890099
Sales Fax: +44 (0) 1723 893303

E-mail: sales@deepseapl.com
Website: www.deepseapl.com

DSE8610 MKII Operator Manual

© Deep Sea Electronics Plc

All rights reserved. No part of this publication may be reproduced in any material form (including photocopying or storing in any medium by electronic means or other) without the written permission of the copyright holder except in accordance with the provisions of the Copyright, Designs and Patents Act 1988.

Applications for the copyright holder's written permission to reproduce any part of this publication must be addressed to Deep Sea Electronics Plc at the address above.

The DSE logo and the names DSEgenset®, DSEats®, DSEcontrol® and DSEpower® are UK registered trademarks of Deep Sea Electronics PLC.

Any reference to trademarked product names used within this publication is owned by their respective companies.

Deep Sea Electronics Plc reserves the right to change the contents of this document without prior notice.

Amendments Since Last Publication

Amd. No.	Comments
1	Initial Release
2	Added information about electrical trip reset
3	Added DSE8660 MKII document part numbers, updated FPE, added EPA screen and J1939-75 support.

TABLE OF CONTENTS

Section	Page
1 INTRODUCTION.....	8
1.1 CLARIFICATION OF NOTATION.....	9
1.2 GLOSSARY OF TERMS.....	9
1.3 BIBLIOGRAPHY	11
1.3.1 INSTALLATION INSTRUCTIONS.....	11
1.3.2 MANUALS	11
1.3.3 TRAINING GUIDES	12
1.3.4 THIRD PARTY DOCUMENTS	12
2 SPECIFICATION.....	13
2.1 OPERATING TEMPERATURE.....	13
2.1.1 SCREEN HEATER OPERATION.....	13
2.2 REQUIREMENTS FOR UL	13
2.3 TERMINAL SPECIFICATION	14
2.4 POWER SUPPLY REQUIREMENTS.....	14
2.4.1 MODULE SUPPLY INSTRUMENTATION DISPLAY	14
2.5 VOLTAGE & FREQUENCY SENSING	15
2.6 CURRENT SENSING	15
2.6.1 VA RATING OF THE CTS.....	16
2.6.2 CT POLARITY	17
2.6.3 CT PHASING.....	17
2.6.4 CT CLASS.....	17
2.7 INPUTS.....	18
2.7.1 DIGITAL INPUTS	18
2.7.2 EMERGENCY STOP	18
2.7.3 ANALOGUE INPUTS	19
2.7.3.1 ANALOGUE INPUT A	19
2.7.3.2 ANALOGUE INPUT B, C & D	20
2.7.4 CHARGE FAIL INPUT	21
2.7.5 MAGNETIC PICK-UP	21
2.8 OUTPUTS.....	22
2.8.1 DC OUTPUTS A & B (FUEL & START).....	22
2.8.2 CONFIGURABLE VOLT-FREE RELAY OUTPUTS C & D.....	22
2.8.3 CONFIGURABLE DC OUTPUTS E, F, G, H, I, J, K & L.....	22
2.8.4 GOVERNOR CONTROL OUTPUT	22
2.8.5 AVR CONTROL OUTPUT.....	22
2.9 COMMUNICATION PORTS.....	23
2.10 COMMUNICATION PORT USAGE.....	24
2.10.1 USB SLAVE PORT (PC CONFIGURATION).....	24
2.10.1.1 USB HOST PORT (DATA LOGGING).....	24
2.10.2 RS232 PORT.....	25
2.10.2.1 RECOMMENDED EXTERNAL MODEMS.....	25
2.10.2.2 RECOMMENDED PC RS232 SERIAL PORT ADD-ONS	26
2.10.3 RS485 PORT.....	27
2.10.3.1 CABLE SPECIFICATION.....	27
2.10.3.2 RECOMMENDED PC RS485 SERIAL PORT ADD-ONS	28
2.10.3.3 RS485 USED FOR MODBUS ENGINE CONNECTION	29
2.10.4 ETHERNET PORT	30
2.10.4.1 DIRECT PC CONNECTION.....	31
2.10.4.2 CONNECTION TO BASIC ETHERNET.....	32
2.10.4.3 CONNECTION TO COMPANY ETHERNET INFRASTRUCTURE	33
2.10.4.4 CONNECTION TO THE INTERNET.....	34
2.10.4.5 FIREWALL CONFIGURATION FOR INTERNET ACCESS	35
2.10.5 MSC (MULTI-SET COMMUNICATIONS) LINK	36
2.10.7 CAN PORT	37
2.10.8 ECU PORT (J1939).....	37

2.10.8.1	J1939-75	38
2.10.9	DSENET® (EXPANSION MODULES).....	42
2.10.9.1	DSENET® USED FOR MODBUS ENGINE CONNECTION	43
2.11	SOUNDER	44
2.11.1	ADDING AN EXTERNAL SOUNDER	44
2.12	ACCUMULATED INSTRUMENTATION	44
2.13	DIMENSIONS AND MOUNTING	45
2.13.1	DIMENSIONS.....	45
2.13.2	PANEL CUTOUT.....	45
2.13.3	WEIGHT	45
2.13.4	FIXING CLIPS	46
2.13.5	CABLE TIE FIXING POINTS.....	47
2.13.6	SILICON SEALING GASKET.....	47
2.14	APPLICABLE STANDARDS	48
2.14.1	ENCLOSURE CLASSIFICATIONS.....	50
2.14.1.1	IP CLASSIFICATIONS.....	50
2.14.1.2	NEMA CLASSIFICATIONS.....	50
3	INSTALLATION.....	51
3.1	USER CONNECTIONS	51
3.2	CONNECTION DESCRIPTIONS	52
3.2.1	DC SUPPLY, E-STOP INPUT, DC OUTPUTS & CHARGE FAIL INPUT.....	52
3.2.2	ANALOGUE SENSOR INPUTS & CAN.....	53
3.2.3	MPU, ECU, MSC & DSENET®.....	54
3.2.4	OUTPUT C & D & V1 (GENERATOR) VOLTAGE & FREQUENCY SENSING	55
3.2.5	V2 (BUS) VOLTAGE & FREQUENCY SENSING.....	55
3.2.6	CURRENT TRANSFORMERS.....	56
3.2.6.1	CT CONNECTIONS.....	57
3.2.7	DIGITAL INPUTS	57
3.2.8	RS485.....	58
3.2.9	RS232.....	59
3.2.10	USB SLAVE (PC CONFIGURATION) CONNECTOR	60
3.2.11	USB HOST (DATA LOGGING) CONNECTOR.....	60
3.3	TYPICAL WIRING DIAGRAM.....	61
3.3.1	(3 PHASE 4 WIRE) WITH RESTRICTED EARTH FAULT	62
3.3.2	EARTH SYSTEMS.....	63
3.3.2.1	NEGATIVE EARTH.....	63
3.3.2.2	POSITIVE EARTH	63
3.3.2.3	FLOATING EARTH.....	63
3.3.3	TYPICAL ARRANGEMENT OF DSENET®.....	64
3.3.4	TYPICAL ARRANGEMENT OF MSC LINK	65
3.4	ALTERNATE TOPOLOGY WIRING DIAGRAMS	66
3.4.1	SINGLE PHASE (L1 & N) 2 WIRE WITH RESTRICTED EARTH FAULT	66
3.4.2	SINGLE PHASE (L1 & N) 2 WIRE WITHOUT EARTH FAULT	67
3.4.3	SINGLE PHASE (L1 & L2) 3 WIRE WITH RESTRICTED EARTH FAULT.....	68
3.4.4	SINGLE PHASE (L1 & L2) 3 WIRE WITHOUT EARTH FAULT	69
3.4.5	SINGLE PHASE (L1 & L3) 3 WIRE WITH RESTRICTED EARTH FAULT.....	70
3.4.6	SINGLE PHASE (L1 & L3) 3 WIRE WITHOUT EARTH FAULT	71
3.4.7	2 PHASE (L1 & L2) 3 WIRE WITH RESTRICTED EARTH FAULT.....	72
3.4.8	2 PHASE (L1 & L2) 3 WIRE WITHOUT EARTH FAULT	73
3.4.9	2 PHASE (L1 & L3) 3 WIRE WITH RESTRICTED EARTH FAULT.....	74
3.4.10	2 PHASE (L1 & L3) 3 WIRE WITHOUT EARTH FAULT	75
3.4.11	3 PHASE 3 WIRE DELTA WITHOUT EARTH FAULT.....	76
3.4.12	3 PHASE 4 WIRE WITHOUT EARTH FAULT	77
3.4.13	3 PHASE 4 WIRE WITH RESTRICTED EARTH FAULT.....	78
3.4.14	3 PHASE 4 WIRE WITH UNRESTRICTED EARTH FAULT	79
3.5	TYPICAL SINGLE LINE APPLICATION DRAWINGS.....	80
3.5.1	MULTI GENERATORS FOR PRIME POWER.....	80
3.5.2	MULTI GENERATORS FOR PRIME POWER WITH BUS COUPLERS.....	81
3.5.3	MULTI GENERATORS WITH SINGLE SYNCHRONISING TRANSFER SWITCH	82

3.5.4	MULTI GENERATORS WITH TWO SYNCHRONISING TRANSFER SWITCHES	83
3.5.5	MULTI GENERATORS & SYNCHRONISING TRANSFER SWITCHES.....	84
3.5.6	MULTI GENERATORS & TRANSFER SWITCHES WITH BUS COUPLER	85
3.5.7	SINGLE GENERATOR EXPORTING (BASE LOADING) POWER	86
3.5.8	MULTI GENERATORS EXPORTING (BASE LOADING) POWER	87
4	DESCRIPTION OF CONTROLS.....	88
4.1	CONTROL PUSH BUTTONS	90
4.2	VIEWING THE INSTRUMENT PAGES.....	92
4.2.1	STATUS	93
4.2.1.1	GENERATOR LOCKED OUT	93
4.2.1.2	WAITING FOR GENERATOR	93
4.2.1.3	CONFIGURABLE STATUS SCREENS	94
4.2.2	ENGINE	95
4.2.2.1	MANUAL FUEL PUMP CONTROL.....	96
4.2.2.2	DPF REGENERATION LAMPS	97
4.2.3	GENERATOR.....	98
4.2.3.1	COMMISIONING SCREENS	99
4.2.3.2	SYNCHROSCOPE.....	100
4.2.4	BUS	100
4.2.5	EXPANSION.....	101
4.2.6	ALARMS.....	102
4.2.6.1	ECU ALARMS (CAN FAULT CODES / DTC)	103
4.2.7	EVENT LOG	104
4.2.7.1	PROTECTIONS DISABLED	105
4.2.7.2	RESET ELECTRICAL TRIP	105
4.2.8	SERIAL PORT.....	106
4.2.8.1	RS232 SERIAL PORT	106
4.2.8.2	RS485 SERIAL PORT	110
4.2.9	ABOUT	111
4.2.9.1	MODULE INFORMATION.....	111
4.2.9.2	ETHERNET	112
4.2.9.3	DATA LOGGING	113
4.3	USER CONFIGURABLE INDICATORS	114
5	OPERATION.....	115
5.1	QUICKSTART GUIDE.....	115
5.1.1	STARTING THE ENGINE	115
5.1.2	STOPPING THE ENGINE	116
5.2	STOP/RESET MODE	117
5.2.1	ECU OVERRIDE	117
5.3	MANUAL MODE	118
5.3.1	STARTING SEQUENCE	118
5.3.2	ENGINE RUNNING.....	119
5.3.3	STOPPING SEQUENCE.....	119
5.4	AUTOMATIC MODE	120
5.4.1	WAITING IN AUTO MODE.....	120
5.4.2	STARTING SEQUENCE	121
5.4.3	ENGINE RUNNING.....	122
5.4.4	STOPPING SEQUENCE.....	122
5.5	SCHEDULER	123
5.5.1	STOP MODE	123
5.5.2	MANUAL MODE.....	123
5.5.3	AUTO MODE.....	123
5.6	MSC COMPATIBILITY MODE.....	124
5.7	ALTERNATIVE CONFIGURATIONS.....	125
5.8	DUMMY LOAD / LOAD SHEDDING CONTROL.....	125
5.8.1	DUMMY LOAD CONTROL	125
5.8.2	LOAD SHEDDING CONTROL	126
5.9	SMS CONTROL	127
5.10	DEAD BUS SYNCHRONISING (AUTO MODE)	128

5.10.1	BENEFIT OF SYSTEM	128
5.10.2	HARDWARE REQUIREMENTS	128
5.10.3	OPERATION	129
6	PROTECTIONS	130
6.1	ALARMS	130
6.1.1	PROTECTIONS DISABLED.....	131
6.1.2	RESET ELECTRICAL TRIP	132
6.1.3	ECU ALARMS (CAN FAULT CODES / DTC)	133
6.2	INDICATIONS	134
6.3	WARNING ALARMS.....	135
6.4	ELECTRICAL TRIP ALARMS	141
6.5	SHUTDOWN ALARMS	147
6.6	MAINTENANCE ALARMS.....	153
6.7	OVER CURRENT ALARM.....	155
6.7.1	IMMEDIATE WARNING	155
6.7.2	INVERSE DEFINITE MINIMUM TIME (IDMT) ALARM.....	156
6.7.2.1	CREATING A SPREADSHEET FOR THE OVER CURRENT IDMT CURVE	157
6.8	SHORT CIRCUIT IDMT ALARM.....	159
6.8.1	CREATING A SPREADSHEET FOR THE SHORT CIRCUIT IDMT CURVE	160
6.9	EARTH FAULT IDMT ALARM.....	162
6.9.1	CREATING A SPREADSHEET FOR THE EARTH FAULT IDMT CURVE	163
6.10	DEFAULT CURRENT PROTECTION TRIPPING CHARACTERISTICS	165
7	FRONT PANEL CONFIGURATION.....	167
7.1	MAIN CONFIGURATION EDITOR	168
7.1.1	ACCESSING THE MAIN CONFIGURATION EDITOR.....	168
7.1.2	ENTERING PIN	168
7.1.3	EDITING A PARAMETER	169
7.1.4	EXITING THE MAIN CONFIGURATION EDITOR.....	169
7.1.5	ADJUSTABLE PARAMETERS	170
7.2	'RUNNING' CONFIGURATION EDITOR.....	172
7.2.1	ACCESSING THE 'RUNNING' CONFIGURATION EDITOR	172
7.2.2	ENTERING PIN	172
7.2.3	EDITING A PARAMETER	172
7.2.4	EXITING THE 'RUNNING' CONFIGURATION EDITOR	173
7.2.5	RUNNING EDITOR PARAMETERS	173
8	COMMISIONING.....	174
8.1	BASIC CHECKS	174
8.2	DSE 4 STEPS TO SUCCESSFUL SYNCHRONISING	175
8.2.1	CONTROL.....	176
8.2.1.1	DETERMINING CONNECTIONS AND SETTINGS FOR GOVERNORS	176
8.2.1.2	DETERMINING CONNECTIONS AND SETTINGS FOR AVRS	178
8.2.2	METERING.....	180
8.2.2.1	CTS ON THE RIGHT PHASE	180
8.2.2.2	CTS IN THE RIGHT DIRECTION	180
8.2.3	COMMUNICATIONS.....	181
8.2.4	SYNC CHECKS.....	182
8.2.4.1	INCORRECTLY WIRED BREAKER	183
8.2.4.2	CORRECTLY WIRED BREAKER.....	184
9	FAULT FINDING.....	185
9.1	STARTING	185
9.2	LOADING	185
9.3	ALARMS	186
9.4	COMMUNICATIONS	186
9.5	INSTRUMENTS.....	186
9.6	SYNCHRONISING & LOAD SHARING	187
9.7	MISCELLANEOUS.....	187
10	MAINTENANCE, SPARES, REPAIR AND SERVICING	188

10.1	PURCHASING ADDITIONAL CONNECTOR PLUGS FROM DSE.....	188
10.1.1	PACK OF PLUGS	188
10.1.2	INDIVIDUAL PLUGS	188
10.2	PURCHASING ADDITIONAL FIXING CLIPS FROM DSE.....	188
10.3	PURCHASING ADDITIONAL SEALING GASKET FROM DSE	189
10.4	DSENET® EXPANSION MODULES	189
11	WARRANTY	190
12	DISPOSAL	190
12.1	WEEE (WASTE ELECTRICAL AND ELECTRONIC EQUIPMENT)	190

1 INTRODUCTION

This document details the installation and operation requirements of the DSE8610 MKII module and is part of the DSE Genset® range of products.

The manual forms part of the product and should be kept for the entire life of the product. If the product is passed or supplied to another party, ensure that this document is passed to them for reference purposes.

This is not a *controlled document*. DSE do not automatically inform on updates. Any future updates of this document are included on the DSE website at www.deepseapl.com

The DSE86xx MKII series is designed to provide differing levels of functionality across a common platform. This allows the generator OEM greater flexibility in the choice of controller to use for a specific application.

The DSE8610 MKII module has been designed to allow the operator to start, stop and synchronise the generator, and if required, transfer the load to the generator either manually or automatically.

Synchronising and Load Sharing features are included within the controller, along with the necessary protections for such a system.

The user also has the facility to view the system operating parameters via the text LCD display.

The DSE8610 MKII module monitors the engine, indicating the operational status and fault conditions, automatically shutting down the engine and giving a true first up fault condition of an engine failure by the text LCD display.

The powerful ARM microprocessor contained within the module allows for incorporation of a range of complex features:

Text based LCD display

True RMS Voltage

Current and Power monitoring

USB, RS232, RS485 and Ethernet Communications

Engine parameter monitoring.

Fully configurable inputs for use as alarms or a range of different functions.

Engine ECU interface to electronic engines including Tier 4 engines.

Synchronising and load sharing with load demand start/stop

Integral PLC to help provide customisation where required

Fuel tank level monitoring to track fuel filling operations and detect fuel leak/theft

Data Logging

Direct connection to governor / AVR for synchronising and load sharing

R.O.C.O.F. and vector shift protection for detection of mains failure when in parallel with the mains.



The DSE Configuration Suite PC Software allows alteration of selected operational sequences, timers, alarms and operational sequences. Additionally, the module's integral front panel configuration editor allows adjustment of this information.

Access to critical operational sequences and timers for use by qualified engineers, can be protected by a security code. Module access can also be protected by PIN code. Selected parameters can be changed from the module's front panel.

The module is housed in a robust plastic case suitable for panel mounting. Connections to the module are via locking plug and sockets.

1.1 CLARIFICATION OF NOTATION

Clarification of notation used within this publication.

 NOTE:	Highlights an essential element of a procedure to ensure correctness.
 CAUTION!	Indicates a procedure or practice, which, if not strictly observed, could result in damage or destruction of equipment.
 WARNING!	Indicates a procedure or practice, which could result in injury to personnel or loss of life if not followed correctly.

1.2 GLOSSARY OF TERMS

Term	Description
DSE8000 MKII, DSE8xxx MKII	All modules in the DSE8xxx MKII range.
DSE8600 MKII, DSE86xx MKII	All modules in the DSE86xx MKII range.
DSE8610 MKII	DSE8610 MKII module/controller
DSE8x10	DSE8610, DSE8610 MKII, DSE8710 and DSE8810 module/controller
DSE8x60	DSE8660, DSE8660 MKII, DSE8760 and DSE8860 module/controller
DSE8x80	DSE8680 module/controller
CAN	Controller Area Network Vehicle standard to allow digital devices to communicate to one another.
CDMA	Code Division Multiple Access. Cell phone access used in small number of areas including parts of the USA and Australia.
CT	Current Transformer An electrical device that takes a large AC current and scales it down by a fixed ratio to a smaller current.
BMS	Building Management System A digital/computer based control system for a building's infrastructure.
DEF	Diesel Exhaust Fluid (AdBlue) A liquid used as a consumable in the SCR process to lower nitric oxide and nitrogen dioxide concentration in engine exhaust emissions.
DM1	Diagnostic Message 1 A DTC that is currently active on the engine ECU.
DM2	Diagnostic Message 2 A DTC that was previously active on the engine ECU and has been stored in the ECU's internal memory.
DPF	Diesel Particulate Filter A filter fitted to the exhaust of an engine to remove diesel particulate matter or soot from the exhaust gas.
DPTC	Diesel Particulate Temperature Controlled Filter A filter fitted to the exhaust of an engine to remove diesel particulate matter or soot from the exhaust gas which is temperature controlled.
DTC	Diagnostic Trouble Code The name for the entire fault code sent by an engine ECU.
ECU/ECM	Engine Control Unit/Management An electronic device that monitors engine parameters and regulates the fuelling.
FMI	Failure Mode Indicator A part of DTC that indicates the type of failure, e.g. high, low, open circuit etc.

Continued over page...

Term	Description
GSM	Global System for Mobile communications. Cell phone technology used in most of the World.
HEST	High Exhaust System Temperature Initiates when DPF filter is full in conjunction with an extra fuel injector in the exhaust system to burn off accumulated diesel particulate matter or soot.
HMI	Human Machine Interface A device that provides a control and visualisation interface between a human and a process or machine.
IDMT	Inverse Definite Minimum Time
MSC	Multi-Set Communication
OC	Occurrence Count A part of DTC that indicates the number of times that failure has occurred.
PGN	Parameter Group Number A CAN address for a set of parameters that relate to the same topic and share the same transmission rate.
PLC	Programmable Logic Controller A programmable digital device used to create logic for a specific purpose.
SCADA	Supervisory Control And Data Acquisition A system that operates with coded signals over communication channels to provide control and monitoring of remote equipment
SCR	Selective Catalytic Reduction A process that uses DEF with the aid of a catalyst to convert nitric oxide and nitrogen dioxide into nitrogen and water to reduce engine exhaust emission.
SIM	Subscriber Identity Module. The small card supplied by the GSM/CDMA provider that is inserted into the cell phone, GSM modem or DSEGateway device to give GSM/GPRS connection.
SMS	Short Message Service The text messaging service of mobile/cell phones.
SPN	Suspect Parameter Number A part of DTC that indicates what the failure is, e.g. oil pressure, coolant temperature, turbo pressure etc.

1.3 BIBLIOGRAPHY

This document refers to, and is referred by the following DSE publications which are obtained from the DSE website: www.deepseapl.com or by contacting DSE technical support: support@deepseapl.com.

1.3.1 INSTALLATION INSTRUCTIONS

Installation instructions are supplied with the product in the box and are intended as a 'quick start' guide only.

DSE Part	Description
053-032	DSE2548 LED Expansion Annunciator Installation Instructions
053-033	DSE2130 Input Expansion Installation Instructions
053-034	DSE2157 Output Expansion Installation Instructions
053-125	DSE2131 Ratio-metric Input Expansion Installation Instructions
053-126	DSE2133 RTD/Thermocouple Input Expansion Installation Instructions
053-134	DSE2152 Ratio-metric Output Expansion Installation Instructions
053-182	DSE8610 MKII Installation Instructions
053-184	DSE8660 MKII Installation Instructions

1.3.2 MANUALS

Product manuals are obtained from the DSE website: www.deepseapl.com or by contacting DSE technical support: support@deepseapl.com.

DSE Part	Description
N/A	DSEGencomm (MODBUS protocol for DSE controllers)
057-004	Electronic Engines and DSE Wiring Guide
057-045	Guide to Synchronising and Load Sharing Part 1 (Usage of DSE Load Share Controllers in synchronisation / load sharing systems.)
057-046	Guide to Synchronising and Load Sharing Part 2 (Governor & AVR Interfacing)
057-047	Load Share System Design and Commissioning Guide
057-082	DSE2130 Input Expansion Operator Manual
057-083	DSE2157 Output Expansion Operator Manual
057-084	DSE2548 Annunciator Expansion Operator Manual
057-139	DSE2131 Ratio-metric Input Expansion Manual
057-140	DSE2133 RTD/Thermocouple Expansion Manual
057-141	DSE2152 Ratio-metric Output Expansion Manual
057-151	DSE Configuration Suite PC Software Installation & Operation Manual
057-175	PLC Programming Guide For DSE Controllers
057-220	Options for Communications with DSE Controllers
057-238	DSE8610 MKII Configuration Suite PC Software Manual
057-257	DSE8660 MKII Configuration Suite PC Software Manual
057-259	DSE8660 MKII Operator Manual

1.3.3 TRAINING GUIDES

Training guides are provided as 'hand-out' sheets on specific subjects during training sessions and contain specific information regarding to that subject.

DSE Part	Description
056-001	Four Steps To Synchronising
056-005	Using CTs With DSE Products
056-006	Introduction to Comms
056-010	Over Current Protection
056-011	MSC Link
056-013	Load Demand Scheme
056-018	Negative Phase Sequence
056-019	Earth Fault Protection
056-020	Loss Of Excitation
056-021	Mains Decoupling
056-022	Breaker Control
056-023	Adding New CAN Files
056-024	GSM Modem
056-026	kW, kvar, kVA and pf.
056-029	Smoke Limiting
056-030	Module PIN Codes
056-033	Synchronising Requirements
056-036	Expansion Modules
056-043	Sync Process
056-045	PLC as Load Demand Controller
056-047	Out of Sync and Failed To Close
056-051	Sending DSEGencomm Control Keys
056-053	Recommended Modems
056-054	DSE xx10 In Fixed Export
056-055	Alternate Configurations
056/057	SW1 & SW2
056-069	Firmware Update
056-071	DSE8610 Auto Test Manual
056-072	Dead Bus Synchronising
056-075	Adding Language Files
056-076	Reading DSEGencomm Alarms
056-079	Reading DSEGencomm Status
056-080	MODBUS
056-081	Screen Heaters
056-082	Override Gencomm PLC Example
056-083	Synchronising & Loadsharing
056-086	G59

1.3.4 THIRD PARTY DOCUMENTS

The following third party documents are also referred to:

Reference	Description
ISBN 1-55937-879-4	IEEE Std C37.2-1996 IEEE Standard Electrical Power System Device Function Numbers and Contact Designations. Institute of Electrical and Electronics Engineers Inc
ISBN 0-7506-1147-2	Diesel generator handbook. L.L.J. Mahon
ISBN 0-9625949-3-8	On-Site Power Generation. EGSA Education Committee.

2 SPECIFICATION

2.1 OPERATING TEMPERATURE

Module	Specification
DSE86xx MKII	-30 °C +70 °C (-22 °F +158 °F)
Display Heater Variants	-40 °C +70 °C (-40 °F +158 °F)

2.1.1 SCREEN HEATER OPERATION

Screen Heater Function	Specification
Turn On When Temperature Falls Below	-10 °C (+14 °F)
Turn Off When Temperature Rises Above	-5 °C (+23 °F)

2.2 REQUIREMENTS FOR UL

Description	Specification
Screw Terminal Tightening Torque	4.5 lb-in (0.5 Nm)
Conductors	<p>Terminals suitable for connection of conductor size 12 AWG to 26 AWG (0.5 mm² to 2.0 mm²).</p> <p>Conductor protection must be provided in accordance with NFPA 70, Article 240</p> <p>Low voltage circuits (35 V or less) must be supplied from the engine starting battery or an isolated secondary circuit.</p> <p>The communication, sensor, and/or battery derived circuit conductors shall be separated and secured to maintain at least ¼" (6 mm) separation from the generator and mains connected circuit conductors unless all conductors are rated 600 V or greater.</p>
Current Inputs	Must be connected through UL Listed or Recognized isolating current transformers with the secondary rating of 5 A max.
Communication Circuits	Must be connected to communication circuits of UL Listed equipment
Output Pilot Duty	0.5 A
Mounting	<p>Suitable for use in type 1 Enclosure Type rating with surrounding air temperature -22 °F to +158 °F (-30 °C to +70 °C)</p> <p>Suitable for pollution degree 3 environments when voltage sensing inputs do not exceed 300 V. When used to monitor voltages over 300 V device to be installed in an unventilated or filtered ventilation enclosure to maintain a pollution degree 2 environment.</p>
Operating Temperature	-22 °F to +158 °F (-30 °C to +70 °C)
Storage Temperature	-40 °F to +176 °F (-40 °C to +80 °C)

2.3 TERMINAL SPECIFICATION

Description	Specification	
Connection Type	Two part connector. Male part fitted to module Female part supplied in module packing case - Screw terminal, rising clamp, no internal spring.	 <p>Example showing cable entry and screw terminals of a 10 way connector</p>
Minimum Cable Size	0.5 mm ² (AWG 24)	
Maximum Cable Size	2.5 mm ² (AWG 12)	
Tightening Torque	0.5 Nm (4.5 lb-in)	
Wire Strip Length	7 mm (9/32")	

2.4 POWER SUPPLY REQUIREMENTS

Description	Specification
Minimum Supply Voltage	5 V continuous
Cranking Dropouts	Able to survive 0 V for 100 ms providing the supply was at least was greater than 5 V for 2 seconds before the dropout and recovers to 5 V afterwards.
Maximum Supply Voltage	35 V continuous (60 V protection)
Reverse Polarity Protection	-35 V continuous
Maximum Operating Current	530 mA at 12 V 280 mA at 24 V
Maximum Standby Current	320 mA at 12 V 120 mA at 24 V
Maximum Current When In Sleep Mode	140 mA at 12 V 75 mA at 24 V
Typical Power (Controller On, Heater Off)	3.8 W to 4.1 W
Typical Power (Controller On, Heater On)	6.8 W to 7.1 W

2.4.1 MODULE SUPPLY INSTRUMENTATION DISPLAY

Description	Specification
Range	0 V to 70 V DC (Maximum continuous operating voltage of 35 V DC)
Resolution	0.1 V
Accuracy	1 % full scale (± 0.35 V)

2.5 VOLTAGE & FREQUENCY SENSING

Description	Specification
Measurement Type	True RMS conversion
Sample Rate	40 kHz
Harmonics	Up to 21 st or better
Input Impedance	300 k Ω phase to neutral
Phase To Neutral	15 V (minimum required for sensing frequency) to 415 V AC (absolute maximum) Suitable for 345 V AC nominal (± 20 % for under/overvoltage detection)
Phase To Phase	25 V (minimum required for sensing frequency) to 720 V AC (absolute maximum) Suitable for 600 V AC nominal (± 20 % for under/overvoltage detection)
Common Mode Offset From Earth	100 V AC (max)
Resolution	1 V AC phase to neutral 2 V AC phase to phase
Accuracy	± 1 % of full scale phase to neutral ± 2 % of full scale phase to phase
Minimum Frequency	3.5 Hz
Maximum Frequency	75.0 Hz
Frequency Resolution	0.1 Hz
Frequency Accuracy	± 0.05 Hz

2.6 CURRENT SENSING

Description	Specification
Measurement Type	True RMS conversion
Sample Rate	40 kHz
Harmonics	Up to 21 st or better
Nominal CT Secondary Rating	1 A and 5 A
Maximum Continuous Current	5 A
Overload Measurement	15 A
Absolute Maximum Overload	50 A for 1 second
Burden	0.5 VA (0.02 Ω current shunts)
Common Mode Offset	70 V peak plant ground to CT common terminal under fault condition
Resolution	25 mA
Accuracy	± 1 % of Nominal (excluding CT error)

2.6.1 VA RATING OF THE CTS

NOTE: Details for 4 mm² cables are shown for reference only. The connectors on the DSE modules are only suitable for cables up to 2.5 mm².

The VA burden of the module on the CTs is 0.5 VA. However depending upon the type and length of cabling between the CTs and the module, CTs with a greater VA rating than the module are required.

The distance between the CTs and the measuring module should be estimated and cross-referenced against the chart opposite to find the VA burden of the cable itself.

If the CTs are fitted within the alternator top box, the star point (common) of the CTs should be connected to system ground (earth) as close as possible to the CTs. This minimises the length of cable used to connect the CTs to the DSE module.

Example:

If 1.5 mm² cable is used and the distance from the CT to the measuring module is 20 m, then the burden of the cable alone is approximately 15 VA. As the burden of the DSE controller is .5 VA, then a CT with a rating of at least 15 VA + 0.5 VA = 15.5 VA must

be used. 0.5 VA, then a CT with a rating of at least 15 VA + 0.5 VA = 15.5 VA must be used. If 2.5 mm² cables are used over the same distance of 20 m, then the burden of the cable on the CT is approximately 7 VA. CT's required in this instance is at least 7.5 VA (7 + 0.5).

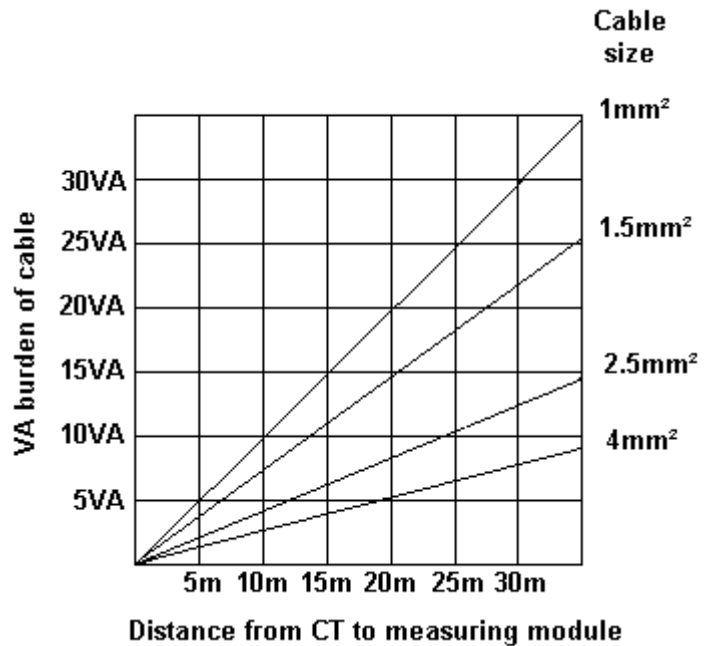

2.6.2 CT POLARITY

NOTE: Take care to ensure correct polarity of the CT primary as shown above. If in doubt, check with the CT supplier.

Take care to ensure the correct polarity of the CTs. Incorrect CT orientation leads to negative kW readings when the set is supplying power. Take note that paper stick-on labels on CTs that show the orientation are often incorrectly placed on the CT. It is more reliable to use the labelling in the case moulding as an indicator to orientation (if available).

To test orientation, run the generator in island mode (not in parallel with any other supply) and load the generator to around 10 % of the set rating. Ensure the DSE module shows positive kW for all three individual phase readings.

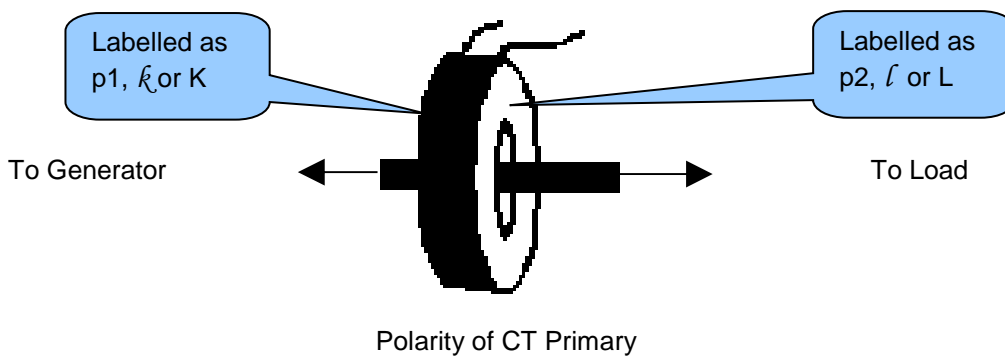

2.6.3 CT PHASING

Take particular care that the CTs are connected to the correct phases. For instance, ensure that the CT on phase 1 is connected to the terminal on the DSE module intended for connection to the CT for phase 1.

Additionally ensure that the voltage sensing for phase 1 is actually connected to generator phase 1. Incorrect connection of the phases as described above results in incorrect power factor (pf) measurements, which in turn results in incorrect kW measurements.

One way to check for this is to make use of a single-phase load. Place the load on each phase in turn, run the generator and ensure the kW value appears in the correct phase. For instance if the load is connected to phase 3, ensure the kW figure appears in phase 3 display and not in the display for phase 1 or 2.

2.6.4 CT CLASS

Ensure the correct CT type is chosen. For instance if the DSE module is providing over current protection, ensure the CT is capable of measuring the overload level required to protect against, and at the accuracy level required.

For instance, this may mean fitting a protection class CT (P15 type) to maintain high accuracy while the CT is measuring overload currents.

Conversely, if the DSE module is using the CT for instrumentation only (current protection is disabled or not fitted to the controller), then measurement class CTs can be used. Again, bear in mind the accuracy required. The DSE module is accurate to better than 1% of the full-scale current reading. To maintain this accuracy, fit a Class 0.5 or Class 1 CT.

Check with the CT manufacturer for further advice on selecting CTs.

2.7 INPUTS

2.7.1 DIGITAL INPUTS

Description	Specification
Number	12 configurable digital inputs (16 when <i>Analogue Inputs</i> are configured as digital inputs)
Arrangement	Contact between terminal and ground
Low Level Threshold	2.1 V minimum
High Level Threshold	6.6 V maximum
Maximum Input Voltage	+50 V DC with respect to plant supply negative
Minimum Input Voltage	-24 V DC with respect to plant supply negative
Contact Wetting Current	7 mA typical
Open Circuit Voltage	12 V typical

2.7.2 EMERGENCY STOP

Description	Specification
Arrangement	Contact between terminal and module supply positive
Closed Threshold	5 V minimum
Open Threshold	3 V maximum
Maximum Input Voltage	+35 V DC with respect to plant supply negative (60 V protection for 1 minute)
Minimum Input Voltage	-24 V DC with respect to plant supply negative
Open Circuit Voltage	0 V

2.7.3 ANALOGUE INPUTS

All of the analogue inputs are flexible within the DSE8610 MKII module

2.7.3.1 ANALOGUE INPUT A

Description	Specification
Input Type	Flexible: Configured for <i>Oil Sensor</i> in the DSE default configuration. Flexible Options: Not used, Digital Input, Flexible Analogue Oil Sensor
Flexible Input Selection	Pressure Sensor, Percentage Sensor or Temperature Sensor
Flexible Measured Quantity	Current, Resistive or Voltage

Resistive Configuration

Description	Specification
Measurement Type	Resistance measurement by measuring voltage across sensor with a fixed current applied
Arrangement	Differential resistance measurement input
Measurement Current	15 mA \pm 2 mA %
Full Scale	480 Ω
Over Range / Fail	600 Ω
Resolution	\pm 1 % of full scale
Accuracy	\pm 2 % of full scale resistance (\pm 9.6 Ω) excluding sensor error
Max Common Mode Voltage	\pm 2 V
Display Range	Configurable by PC Software

0 V to 10 V Configuration

Description	Specification
Full Scale	0 V to 10 V
Over Range / Fail	11 V
Resolution	\pm 1% of full scale
Accuracy	\pm 2% of full scale voltage (\pm 0.2 V) excluding sensor error
Max Common Mode Voltage	\pm 2 V
Display Range	Configurable by PC Software

4 mA to 20 mA Configuration

Description	Specification
Full Scale	0 mA to 20 mA
Over Range / Fail	22 mA
Resolution	1% of full scale
Accuracy	\pm 2% of full scale current (\pm 0.4 mA) excluding sensor error
Max Common Mode Voltage	\pm 2 V
Display Range	Configurable by PC Software

2.7.3.2 ANALOGUE INPUT B, C & D

Description	Specification
Analogue Input B Type	Flexible: Configured for <i>Temperature Sensor</i> in the DSE default configuration. Flexible Options: Not used, Digital Input and Flexible Analogue
Analogue Input C Type	Flexible: Configured for <i>Fuel Sensor</i> in the DSE default configuration. Flexible Options: Not used, Digital Input and Flexible Analogue
Analogue Input D Type	Flexible: Configured for <i>Flexible Analogue</i> in the DSE default configuration. Flexible Options: Not used, Digital Input and Flexible Analogue
Flexible Input Selection	Pressure Sensor, Percentage Sensor or Temperature Sensor
Flexible Measured Quantity	Current, Resistive or Voltage

Resistive Configuration

Description	Specification
Measurement Type	Resistance measurement by measuring voltage across sensor with a fixed current applied
Arrangement	Differential resistance measurement input
Measurement Current	15 mA \pm 10 %
Full Scale	480 Ω
Over Range / Fail	600 Ω
Resolution	\pm 1 % of full scale
Accuracy	\pm 2 % of full scale resistance (\pm 9.6 Ω) excluding sensor error
Max Common Mode Voltage	\pm 2 V
Display Range	Configurable by PC Software

0 V to 10 V Configuration

Description	Specification
Full Scale	0 V to 10 V
Over Range / Fail	11 V
Resolution	\pm 1% of full scale
Accuracy	\pm 2% of full scale voltage (\pm 0.2 V) excluding sensor error
Max Common Mode Voltage	\pm 2 V
Display Range	Configurable by PC Software

4 mA to 20 mA Configuration

Description	Specification
Full Scale	0 mA to 20 mA
Over Range / Fail	22 mA
Resolution	\pm 1% of full scale
Accuracy	\pm 2% of full scale current (\pm 0.4 mA) excluding sensor error
Max Common Mode Voltage	\pm 2 V
Display Range	Configurable by PC Software

2.7.4 CHARGE FAIL INPUT

The charge fail input is actually a combined input and output. Whenever the generator is required to run, the terminal provides excitation current to the charge alternator field winding.

When the charge alternator is correctly charging the battery, the voltage of the terminal is close to the plant battery supply voltage. In a failed charge situation, the voltage of this terminal is pulled down to a low voltage. It is this drop in voltage that triggers the *Charge Failure* alarm. The level at which this operates and whether this triggers a warning or shutdown alarm is configurable using the DSE Configuration Suite Software.

Description	Specification
Minimum Voltage	0 V
Maximum Voltage	35 V
Resolution	0.2 V
Accuracy	±1 % of full scale
Excitation	Active circuit constant power output
Output Power	2.5 W nominal at 12 V and 24 V
Current At 12V	210 mA
Current At 24V	105 mA

2.7.5 MAGNETIC PICK-UP

 **NOTE: DSE supply a suitable magnetic pickup device, available in two body thread lengths:**
DSE Part number 020-012 - Magnetic Pickup probe 5/8 UNF 2 1/2" thread length
DSE Part number 020-013 - Magnetic Pickup probe 5/8 UNF 4" thread length

Magnetic Pickup devices can often be 'shared' between two or more devices. For example, one device can often supply the signal to both the DSE module and the engine governor. The possibility of this depends upon the amount of current that the magnetic pickup can supply.

Description	Specification
Type	Differential input
Minimum Voltage	0.5 V RMS
Maximum Voltage	70 V RMS
Max Common Mode Voltage	±2 V peak
Minimum Frequency	5 Hz
Maximum Frequency	10,000 Hz
Resolution	6.25 rpm
Accuracy	± 25 rpm
Flywheel Teeth	10 to 500

2.8 OUTPUTS

2.8.1 DC OUTPUTS A & B (FUEL & START)

Description	Specification
Type	Normally used as Fuel & Start outputs. Fully configurable for other purposes if the module is configured to control an electronic engine.
Rating	15 A resistive at Emergency Stop supply.

2.8.2 CONFIGURABLE VOLT-FREE RELAY OUTPUTS C & D

Description	Specification
Type	Normally used for load switching control Fully configurable volt-free relays. Output C normally closed and Output D normal open.
Rating	8 A resistive at 250 V AC

2.8.3 CONFIGURABLE DC OUTPUTS E, F, G, H, I, J, K & L

Description	Specification
Type	Fully configurable, supplied from DC supply terminal 2.
Rating	2 A resistive at module supply.

2.8.4 GOVERNOR CONTROL OUTPUT

Description	Specification
Arrangement	Supplied from DC supply terminal 2
Type	Isolated DC output, voltage controlled
Voltage Range	-5 V to +10 V DC
Max Common Mode Voltage	±1 kV
Resolution	Less than 1 mV
Accuracy	±1%
Minimum Load	500 Ω

2.8.5 AVR CONTROL OUTPUT

Description	Specification
Arrangement	Supplied from DC supply terminal 2
Type	Isolated DC output, voltage controlled
Voltage Range	-5 V to +10 V DC
Max Common Mode Voltage	±3 kV
Resolution	Less than 1 mV
Accuracy	±1 %
Minimum Load	500 Ω

2.9 COMMUNICATION PORTS

NOTE: All communication ports can be used at the same time.

Description	Specification
USB Slave Port	Type B USB 2.0 For connection to PC running DSE Configuration Suite Max distance 6 m (20 feet)
USB Host Port	Type A USB 2.0 Capability to add a maximum of 16 GB USB storage device for data recording only
RS232 Serial Port	Non – isolated Max Baud rate 115 k baud subject to configuration TX, RX, RTS, CTS, DSR, DTR, DCD Male 9 way D type connector Max distance 15 m (50 feet)
2 x RS485 Serial Ports	Isolated Data connection 2 wire + common Half Duplex Data direction control for Transmit (by s/w protocol) Max Baud Rate 115 k baud subject to configuration External termination required (120 Ω) Max common mode offset 70 V (on board protection transorb) Max distance 1.2 km (¾ mile)
Ethernet	Auto detecting 10/100 Mbit Ethernet port.
MSC (Multi Set Communication) and CAN Port	<p>NOTE: For additional length, the DSE124 CAN & MSC Extender is available. For more information, refer to DSE Publication: 057-116 DSE124 Operator Manual</p>
	<p>Standard implementation of ‘Slow mode’, up to 250K bits/s Data connection 2 wire + common Isolated External termination required (120 Ω) Max common mode offset 70 V (on board protection transorb) Max distance 250 M using Belden 9841 Cable or equivalent</p>
ECU Port	<p>NOTE: For additional length, the DSE124 CAN & MSC Extender is available. For more information, refer to DSE Publication: 057-116 DSE124 Operator Manual</p>
	<p>Engine CAN Port Standard implementation of ‘Slow mode’, up to 250 Kb/s Non-Isolated. Internal Termination enabled by software configuration provided (120 Ω) Max distance 40 m (133 feet)</p>
DSENet® (Expansion Comms) Port	Non-isolated Data connection 2 wire + common Half Duplex Data direction control for Transmit (by s/w protocol) Baud Rate of 115 k baud Internal termination fitted (120 Ω) Max common mode offset ±5 V Max distance 1.2 km (¾ mile)

2.10 COMMUNICATION PORT USAGE

2.10.1 USB SLAVE PORT (PC CONFIGURATION)

NOTE: DSE stock 2 m (6.5 feet) USB type A to type B cable, DSE Part Number: 016-125. Alternatively they are purchased from any PC or IT store.

NOTE: The DC supply must be connected to the module for configuration by PC.

NOTE: For further details of module configuration, refer to DSE Publication: 057-238 *DSE8610 MKII Configuration Suite PC Software Manual*.

The USB port is provided to give a simple means of connection between a PC and the controller. Using the DSE Configuration Suite Software, the operator is then able to control the module, starting or stopping the engine, selecting operating modes, etc.

Additionally, the various operating parameters (such as coolant temperature, oil pressure, etc.) of the engine are available to be viewed or changed.

To connect a module to a PC by USB, the following items are required:

DSE86xx MKII Controller



DSE Configuration Suite PC Software
(Supplied on configuration suite software CD or available from www.deepseapl.com).



USB cable Type A to Type B.
(This is the same cable as often used between a PC and a USB printer)



DSE can supply this cable if required :
PC Configuration interface lead (USB type A – type B) DSE Part No 016-125

2.10.1.1 USB HOST PORT (DATA LOGGING)

USB Type A connection for an of external USB storage device of maximum 16 GB for instrumentation data logging.

2.10.2 RS232 PORT

NOTE: For direct connection an RS232 null modem (crossover) cable is required. This is rated to a maximum cable length of 15 m.

NOTE: For a single module to PC connection and distances up to 6 m (20 feet) the USB connection method is more suitable and provides for a lower cost alternative to RS485 (which is more suited to longer distance connections).

The RS232 port on the controller supports the MODBUS RTU protocol and is for connection to a single MODBUS master device only.

The MODBUS register table for the controller is available upon request from the DSE Technical Support Department.

RS232 is for short distance communication (max 15m) and is typically used to connect the controller to a telephone or GSM modem for more remote communications.

The various operating parameters (such as coolant temperature, oil pressure, etc.) of the remote engine are viewed or changed.

Many PCs are not fitted with an internal RS232 serial port. DSE DOES NOT recommend the use of USB to RS232 converters but can recommend PC add-ons to provide the computer with an RS232 port.

2.10.2.1 RECOMMENDED EXTERNAL MODEMS

NOTE: For GSM modems a SIM card is required, supplied by the GSM network provider:

For SMS only, a 'normal' voice SIM card is required. This enables the controller to send SMS messages to designated mobile phones upon status and alarm conditions.

For a data connection to a PC running DSE Configuration Suite Software, a 'special' CSD (Circuit Switched Data) SIM card is required that enables the modem to answer an incoming data call. Many 'pay as you go' services do not provide a CSD (Circuit Switched Data) SIM card.

Multitech Global Modem – MultiModem ZBA (PSTN)
DSE Part Number 020-252
(Contact DSE Sales for details of localisation kits for these modems)



Sierra Fastrak Xtend GSM modem kit (PSU, Antenna and modem)*
DSE Part number 0830-001-01



2.10.2.2 RECOMMENDED PC RS232 SERIAL PORT ADD-ONS

NOTE: DSE have no business tie to Brainboxes. Over many years, our own engineers have used these products and are happy to recommend them.

NOTE: For further details of setting up the devices below, refer to the manufacture whose details are below.

Remember to check these parts are suitable for your PC. Consult your PC supplier for further advice.

Brainboxes PM143 PCMCIA RS232 card (for laptop PCs)



Brainboxes VX-001 Express Card RS232 (for laptops and nettops PCs)



Brainboxes UC246 PCI RS232 card (for desktop PCs)



Brainboxes PX-246 PCI Express 1 Port RS232 1 x 9 Pin (for desktop PCs)



Supplier:

Brainboxes

Tel: +44 (0)151 220 2500

Web: <http://www.brainboxes.com>

Email: Sales: sales@brainboxes.com

2.10.3 RS485 PORT

NOTE: For a single module to PC connection and distances up to 6 m (20 feet) the USB connection method is more suitable and provides for a lower cost alternative to RS485 (which is more suited to longer distance connections).

The RS485 port on the controller supports the MODBUS RTU protocol and is for connection to a single MODBUS master device only.

The DSE MODBUS register table for the controller is available upon request from the DSE Technical Support Department.

RS485 is used for point-to-point cable connection of more than one device (maximum 32 devices) and allows for connection to PCs, PLCs and Building Management Systems (to name just a few devices).

One advantage of the RS485 interface is the large distance specification (1.2 km when using Belden 9841 (or equivalent) cable. This allows for a large distance between the module and a PC running the DSE Configuration Suite software. The operator is then able to control the module, starting or stopping the engine, selecting operating modes, etc.

The various operating parameters (such as coolant temperature, oil pressure, etc.) of the remote engine are viewed or changed.

Many PCs are not fitted with an internal RS485 serial port. DSE DOES NOT recommend the use of USB to RS485 convertors but can recommend PC add-ons to provide the computer with an RS485port.

2.10.3.1 CABLE SPECIFICATION

NOTE: DSE recommend Belden 9841 (or equivalent) cable for RS485 communication. This is rated to a maximum cable length of 1.2 km. DSE Stock Belden 9841 cable, DSE Part Number: 016-030.

Description	Specification
Cable Type	Two core screened and shielded twisted pair
Cable Characteristics	120 Ω impedance Low capacitance
Recommended Cable	Belden 9841 Belden 9271
Maximum Cable Length	1200 m (¾ mile) when using Belden 9841 or direct equivalent. 600 m (656 yards) when using Belden 9271 or direct equivalent.
RS485 Topology	“Daisy Chain” Bus with no stubs (spurs)
RS485 Termination	120 Ω. Not fitted internally to module. Must be fitted externally to the ‘first’ and ‘last’ device on the RS485 link.

2.10.3.2 RECOMMENDED PC RS485 SERIAL PORT ADD-ONS

NOTE: DSE have no business tie to Brainboxes. Over many years, our own engineers have used these products and are happy to recommend them.

NOTE: For further details of setting up the devices below, refer to the manufacture whose details are below.

Remember to check these parts are suitable for your PC. Consult your PC supplier for further advice.

Brainboxes PM154 PCMCIA RS485 card (for laptops PCs)
Set to 'Half Duplex, Autogating' with 'CTS True' set to 'enabled'



Brainboxes VX-023 ExpressCard 1 Port RS422/485 (for laptops and nettop PCs)



Brainboxes UC320 PCI Velocity RS485 card (for desktop PCs)
Set to 'Half Duplex, Autogating' with 'CTS True' set to 'enabled'



Brainboxes PX-324 PCI Express 1 Port RS422/485 (for desktop PCs)



Supplier:
Brainboxes
Tel: +44 (0)151 220 2500
Web: <http://www.brainboxes.com>
Email: Sales: sales@brainboxes.com

2.10.3.3 RS485 USED FOR MODBUS ENGINE CONNECTION

NOTE: For further details of module configuration, refer to DSE Publication: 057-238 *DSE8610 MKII Configuration Suite PC Software Manual*.

The RS485 port can be configured for connection to Cummins MODBUS engines (Engines fitted with Cummins GCS (G-Drive Control System)). This leaves the DSENet® interface free for connection to expansion devices.

While this is a very useful feature in some applications, the obvious drawback is that the RS485 interface is no longer available connection or remote monitoring equipment (i.e. Building Management System, PLC or PC RS232 port) or dual mutual system.

Example of configuring the DSENet® for connection to Cummins QSK GCS using the DSE Configuration Suite Software:

The screenshot shows a configuration window titled "ECU (ECM) Options". It contains the following settings:

Option	Value
Engine Type	Cummins QSK
Enhanced J1939	<input type="checkbox"/>
Alternative Engine Speed	<input type="checkbox"/>
Modbus Engine Comms Port	RS485 Port

2.10.4 ETHERNET PORT

The Ethernet port on the controller supports the Modbus TCP protocol and is for connection for up to five Modbus master devices.

 **NOTE: For further details of module configuration, refer to DSE Publication: 057-238 DSE8610 MKII Configuration Suite PC Software Manual.**

The DSE MODBUS register table for the controller is available upon request from the DSE Technical Support Department.

Ethernet is used for point-to-point cable connection of more than one device and allows for connection to PCs, PLCs and Building Management Systems (to name just a few devices).

One advantage of the Ethernet interface is the ability to interface into an existing LAN (Local Area Network) connection for remote connection via an internet connection. This allows for a large distance between the module and a PC running the DSE Configuration Suite software. The operator is then able to control the module, starting or stopping the engine, selecting operating modes, etc.

The various operating parameters (such as coolant temperature, oil pressure, etc.) of the remote engine are viewed or changed.

 **NOTE: For a single module to PC connection and distances up to 6 m (20 feet) the USB connection method is more suitable and provides for a lower cost alternative to Ethernet (which is more suited to longer distance connections).**

 **NOTE: DSE stock 2 m (6.5 feet) Ethernet Cable, DSE Part Number: 016-137. Alternatively they can be purchased from any PC or IT store.**

2.10.4.1 DIRECT PC CONNECTION





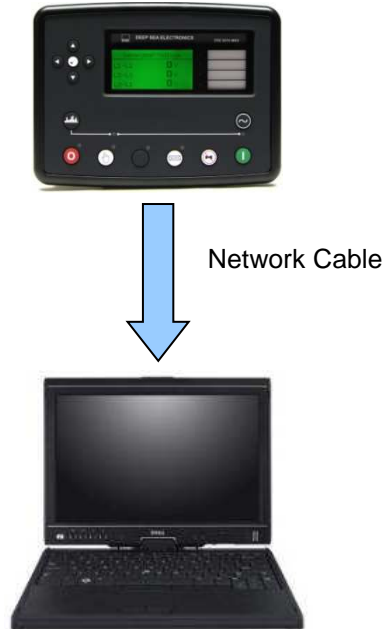







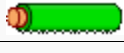
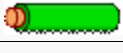

Requirements

- Ethernet cable (see below)
- PC with Ethernet port



Ethernet Cable Wiring Detail

NOTE: DSE stock 2 m (6.5 feet) Ethernet Cable, DSE Part Number: 016-137. Alternatively they can be purchased from any PC or IT store.

Pin	Connection 1 (T568A)	Connection 2 (T568A)
1	 white/green stripe	 white/green stripe
2	 green solid	 green solid
3	 white/orange stripe	 white/orange stripe
4	 blue solid	 blue solid
5	 white/blue stripe	 white/blue stripe
6	 orange solid	 orange solid
7	 white/brown stripe	 white/brown stripe
8	 brown solid	 brown solid

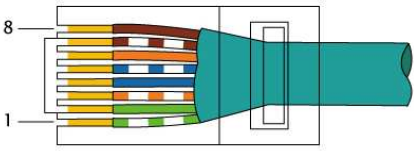

EIA/TIA-568A

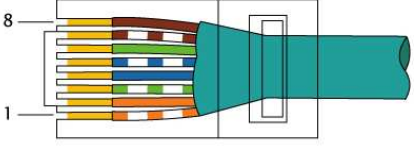

EIA/TIA-568B

2.10.4.2 CONNECTION TO BASIC ETHERNET





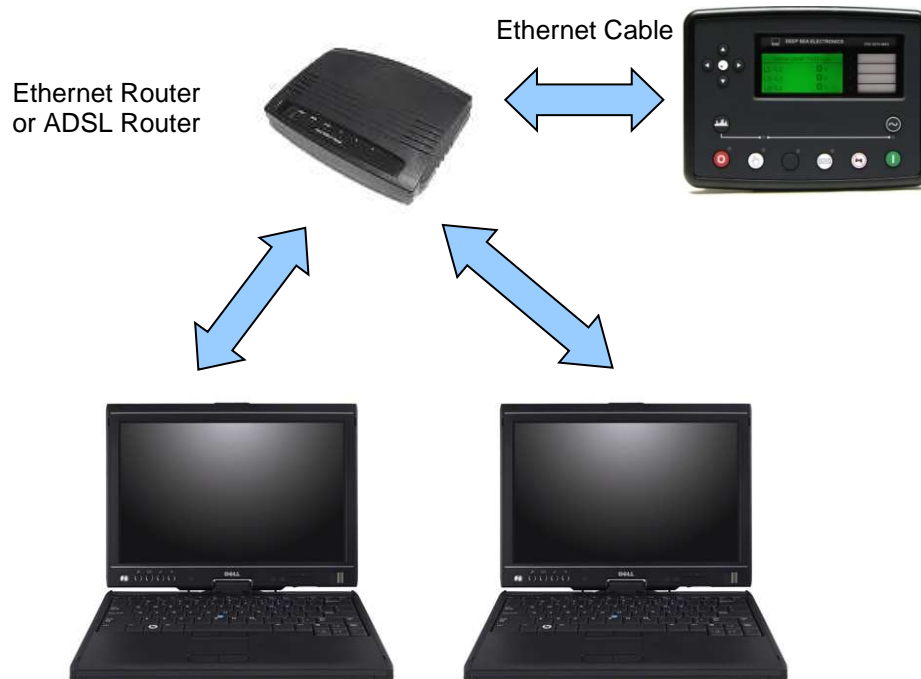





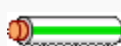
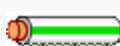



Requirements

- Ethernet cable (see below)
- Working Ethernet (company or home network)
- PC with Ethernet port



Ethernet Cable Wiring Detail

NOTE: DSE stock 2 m (6.5 feet) Ethernet Cable, DSE Part Number: 016-137. Alternatively they can be purchased from any PC or IT store.

Pin	Connection 1 (T568A)	Connection 2 (T568A)
1	 white/green stripe	 white/green stripe
2	 green solid	 green solid
3	 white/orange stripe	 white/orange stripe
4	 blue solid	 blue solid
5	 white/blue stripe	 white/blue stripe
6	 orange solid	 orange solid
7	 white/brown stripe	 white/brown stripe
8	 brown solid	 brown solid

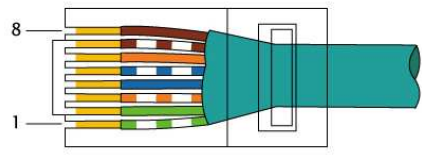

EIA/TIA-568A

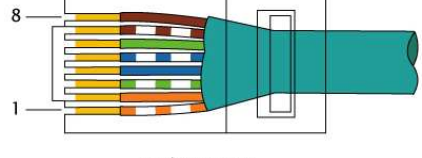

EIA/TIA-568B

2.10.4.3 CONNECTION TO COMPANY ETHERNET INFRASTRUCTURE

Requirements

- DSE module with the ability to connect to Ethernet
- Ethernet cable (see below)
- Working Ethernet (company or home network)
- PC with Ethernet port

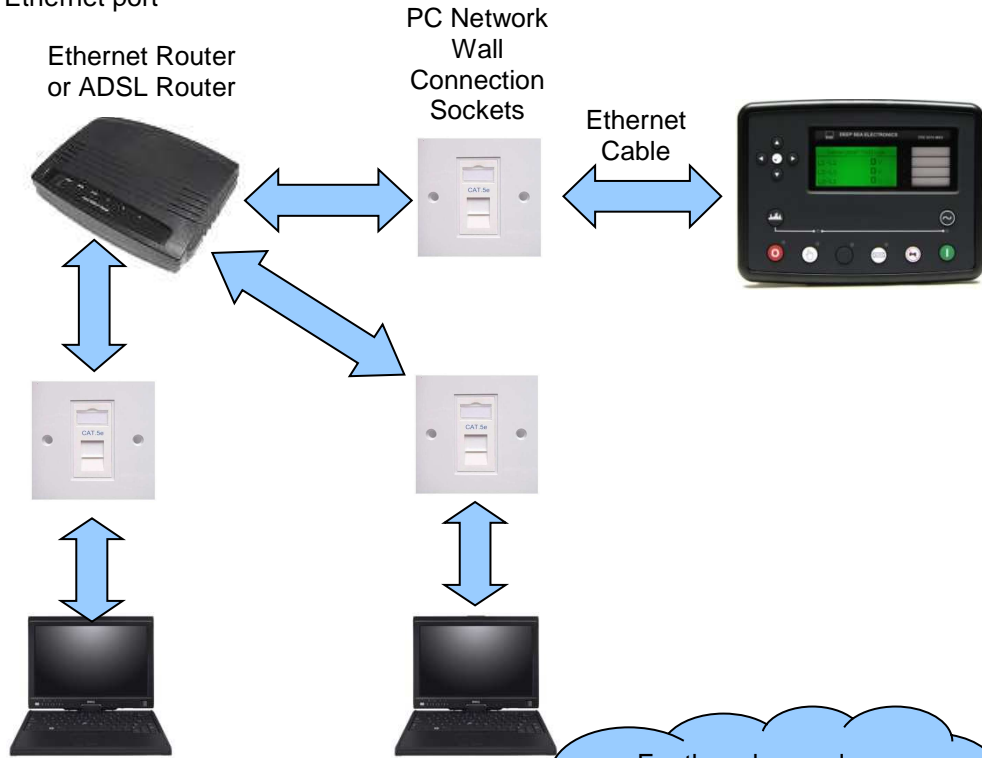

Ethernet Cable Wiring Detail

For the advanced Engineer, this cable has both ends terminated as T568A or T568B.

NOTE: DSE stock 2 m (6.5 feet) Ethernet Cable, DSE can be purchased from any PC or IT store.

Pin	Connection 1 (T568A)	Connection 2 (T568A)
1	white/green stripe	white/green stripe
2	green solid	green solid
3	white/orange stripe	white/orange stripe
4	blue solid	blue solid
5	white/blue stripe	white/blue stripe
6	orange solid	orange solid
7	white/brown stripe	white/brown stripe
8	brown solid	brown solid

2.10.4.4 CONNECTION TO THE INTERNET





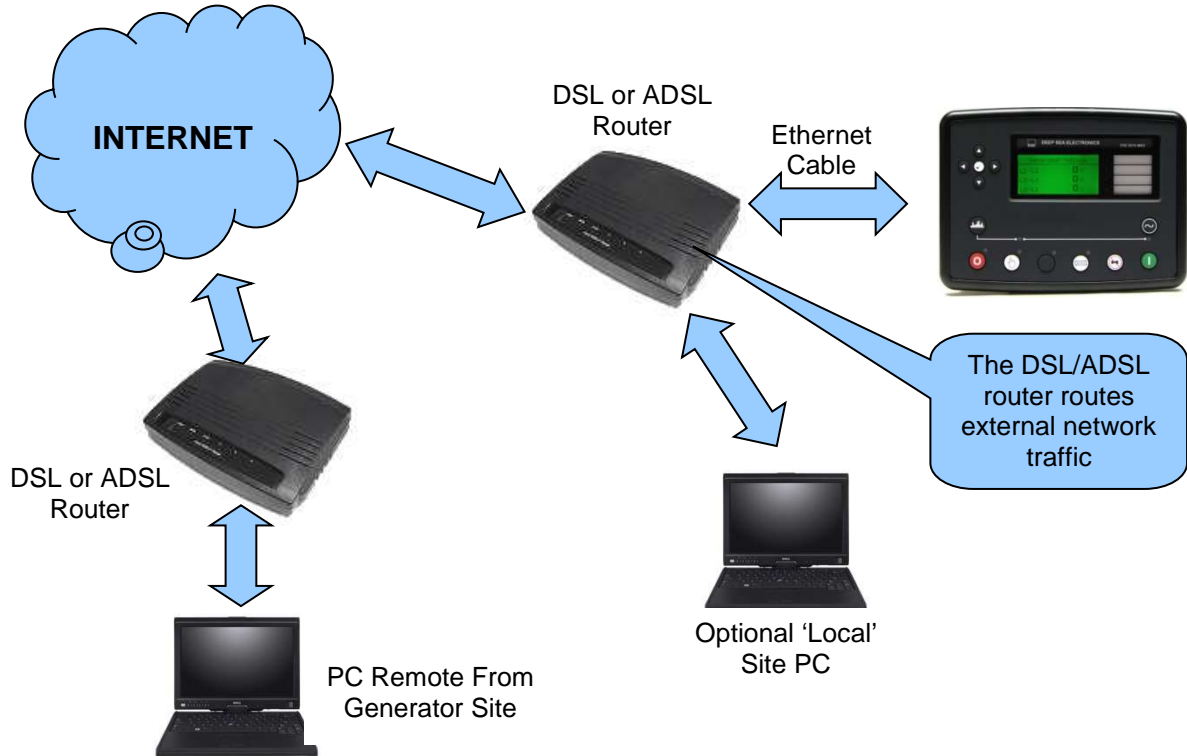









Requirements

- Ethernet cable (see below)
- Working Ethernet (company or home network)
- Working Internet connection (ADSL or DSL recommended)

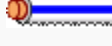

Ethernet Cable Wiring Detail

NOTE: DSE stock 2 m (6.5 feet) Ethernet Cable, DSE Part Number: 016-137. Alternatively they can be purchased from any PC or IT store.

Pin	Connection 1 (T568A)	Connection 2 (T568A)
1	 white/green stripe	 white/green stripe
2	 green solid	 green solid
3	 white/orange stripe	 white/orange stripe
4	 blue solid	 blue solid
5	 white/blue stripe	 white/blue stripe
6	 orange solid	 orange solid
7	 white/brown stripe	 white/brown stripe
8	 brown solid	 brown solid

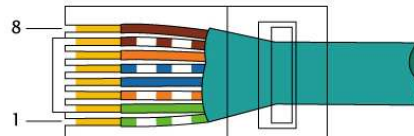

EIA/TIA-568A

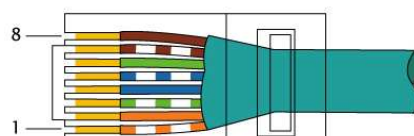

EIA/TIA-568B

2.10.4.5 FIREWALL CONFIGURATION FOR INTERNET ACCESS

 **NOTE: For further details of module configuration, refer to DSE Publication: 057-238 DSE8610 MKII Configuration Suite PC Software Manual.**

As modem/routers differ enormously in their configuration, it is not possible for DSE to give a complete guide to their use with the module. However it is possible to give a description of the requirements in generic terms. For details of how to achieve the connection to your modem/router you are referred to the supplier of your modem/router equipment.

The module makes its data available over Modbus TCP and as such communicates over the Ethernet using a Port configured via the DSE Configuration Suite software.

You must configure your modem/router to allow inbound traffic on this port. For more information you are referred to your WAN interface device (modem/router) manufacturer.

It is also important to note that if the port assigned (setting from software "Modbus Port Number") is already in use on the LAN, the module cannot be used and another port must be used.

Outgoing Firewall Rule

As the module makes its user interface available to standard web browsers, all communication uses the chosen port. It is usual for a firewall to make the same port outgoing open for communication.

Incoming Traffic (Virtual Server)

Network Address and Port Translation (NAPT) allows a single device, such as the modem/router gateway, to act as an agent between the Internet (or "public external network") and a local (or "internal private") network. This means that only a single, unique IP address is required to represent an entire group of computers.

For our application, this means that the WAN IP address of the modem/router is the IP address we need to access the site from an external (internet) location.

When the requests reach the modem/router, we want this passed to a 'virtual server' for handling, in our case this is the module.

Result: Traffic arriving from the WAN (internet) on port xxx is automatically sent to IP address set within the configuration software on the LAN for handling.

2.10.5 MSC (MULTI-SET COMMUNICATIONS) LINK

NOTE: For further details of module configuration, refer to DSE Publication: 057-238 *DSE8610 MKII Configuration Suite PC Software Manual*.

NOTE: A termination resistor **MUST** be fitted to the first and last unit on the MSC link. For connection details, refer to section entitled *Typical Arrangement of MSC Link* elsewhere in this document.

NOTE: DSE recommend Belden 9841 (or equivalent) cable for MSC communication. This is rated to a maximum cable length of 250 m. DSE Stock Belden 9841 cable, DSE Part Number: 016-030.

NOTE: By default the MSC link of the DSE8xxx modules are not compatible with the DSE55xx/DSE75xx modules. For details on enabling compatibility, refer to section entitled *MSC Compatibility* elsewhere in this document.

The MSC link is the interconnection cable between all DSE synchronising controllers and must not be connected to any device other than DSE equipment designed for connection to the MSC link.

Description	Specification
Cable Type	Two core screened and shielded twisted pair
Cable Characteristics	120 Ω Low capacitance
Recommended Cable	Belden 9841 Belden 9271
Maximum Cable Length	<div style="border: 1px solid black; padding: 5px;"> <p>NOTE: For additional length, the DSE124 CAN & MSC Extender is available. For more information, refer to DSE Publication: 057-116 <i>DSE124 Operator Manual</i></p> </div> <p>250 m (¾ mile) when using Belden 9841 or direct equivalent. 125 m (656 yards) when using Belden 9271 or direct equivalent.</p>
MSC Topology	“Daisy Chain” Bus with no stubs (spurs)
MSC Termination	120 Ω. Must be fitted externally to the first and last module.
Maximum DSE8xxx and DSE8xxx MKII Modules	<div style="border: 1px solid black; padding: 5px;"> <p>NOTE: If any number of DSE8x60 are on the MSC link, a maximum of 2x DSE8x80 can be used. For each DSE8x80 used, the number of available DSE8x60s to be used reduces.</p> </div> <p>Total 40 devices made up of DSE8x10 (up to 32), DSE8x60 (up to 16) and DSE8x80 (up to 16)</p> <p>This gives the possibility of :</p> <ul style="list-style-type: none"> • 32 generators (DSE8x10) and 8 synchronising transfers (DSE8x60) • 32 generators (DSE8x10) and 8 generator bus couplers (DSE8x80) • 24 generators (DSE8x10) and 16 synchronising transfers (DSE8x60) • 24 generators (DSE8x10) and 16 generator bus couplers (DSE8x80) • 32 generators (DSE8x10), 14 synchronising transfers (DSE8x60) and 2 generator bus couplers (DSE8x80)

2.10.7 CAN PORT

NOTE: At the time of writing this document the CAN Port is not available. The CAN Port functionality is to be made available in a future update. Contact DSE technical support for further information, support@deepseapl.com.

2.10.8 ECU PORT (J1939)

NOTE: For further details of module configuration, refer to DSE Publication: 057-238 *DSE8610 MKII Configuration Suite PC Software Manual*.

NOTE: For further details on connection to electronic engines, refer to DSE Publication: 057-004 *Electronic Engines And DSE Wiring*

NOTE: Screened 120 Ω impedance cable specified for use with CAN must be used for the CAN link.
DSE stock and supply Belden cable 9841 which is a high quality 120 Ω impedance cable suitable for CAN use (DSE part number 016-030)

NOTE: For additional length, the DSE124 CAN & MSC Extender is available. For more information, refer to DSE Publication: 057-116 *DSE124 Operator Manual*

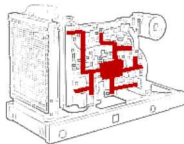

The modules are fitted with a CAN interface as standard and are capable of receiving engine data from engine ECU/ECMs compliant with the CAN J1939 standard.

ECU/ECMs monitor the engine's operating parameters such as speed, oil pressure, coolant temperature (among others) in order to closely monitor and control the engine. The industry standard communications interface (CAN) transports data gathered by the engine's ECU/ECM using the J1939 protocol. This allows engine controllers such as DSE to access these engine parameters with no physical connection to the sensor device.

The *ECU Port* is used for point-to-point cable connection of more than one device and allows for connection to CAN Scanner, PLC and CAN controllers (to name just a few devices). The operator is then able to view the various operating parameters.

2.10.8.1 J1939-75

NOTE: For further details of module configuration, refer to DSE Publication: *057-243 DSE7310 MKII & 7320 MKII Configuration Software Manual*.

When the J1939-75 is enabled in the module's configuration, the module's AC measurements and alarms are sent onto the CANbus using the *ECU Port* to be received by an external monitoring device. There are two check boxes to enable each of the two parts of the interface as shown below, AC measurement and AC related alarms. The module AC alarms are translated into J1939 DM1 diagnostic messages. There are no additional display screens visible on the module when these options are selected.

Miscellaneous Options

J1939-75 Instrumentation Enable

J1939-75 Alarms Enable

The default CAN source address for additional J1939-75 messages is 44 however this may be changed by the generator supplier.

Miscellaneous

CAN source address (engine messages)

CAN source address (instrumentation)

Transmitted PGNs

PGN Message	PGN	Update Rate
DM1	65226	1000 ms
GAAC	65030	1000 ms
GPAAC	65027	1000 ms
GPBAC	65024	1000 ms
GPCAC	65021	1000 ms
GTACP	65029	1000 ms
GTACR	65028	1000 ms
ACS	64913	2500 ms

DM1 Conditions

Key	Value
SPN Generator Average AC Frequency	2436
SPN Generator Average Line to Line AC RMS Voltage	2440
SPN Generator Average Line to Neutral AC RMS Voltage	2444
SPN Generator Average AC RMS Current	2448
FMI_DV_BELOW_NORMAL_LEAST	17
FMI_DV_ABOVE_NORMAL_LEAST	15
FMI_DV_BELOW_NORMAL_MOST	1
FMI_DV_ABOVE_NORMAL_MOST	0

Alarm	SPN	FMI (Warning)	FMI (Shutdown)
Under Frequency	2436	17	1
Over Frequency	2436	15	0
Under Voltage (Line to Line)	2440	17	1
Over Voltage (Line to Line)	2440	15	0
Under Voltage (Line to Neutral)	2444	17	1
Over Voltage (Line to Neutral)	2444	15	0
Over Current	2448	15	0
Oil Pressure Sender Fault	100		2
Oil Pressure Low Shutdown	100		1
Coolant Temperature Sensor Fault	110	2	
Coolant Temperature High Shutdown	110		0
Fuel Level High	96	15	0
Fuel Level Low	96	17	1
Over Speed Shutdown	190		0
Under Speed Shutdown	190		1
Plant Battery Over Voltage Warning	168	15	
Plant Battery Under Voltage Warning	168	17	
Charge Alternator Voltage	167	17	1

Alternator Instrumentation

Instrument	SPN	PGN	PGN Message	Units	Scaling
Generator Average AC RMS Current	2448	65030	GAAC	A	1
Generator Average AC Frequency	2436	65030	GAAC	Hz	128
Generator Average Line to Neutral AC RMS Voltage	2444	65030	GAAC	V	1
Generator Average Line to Line AC RMS Voltage	2440	65030	GAAC	V	1
Generator Phase A AC RMS Current	2449	65027	GPAAC	A	1
Generator Phase A AC Frequency	2437	65027	GPAAC	Hz	128
Generator Phase A Line to Neutral AC RMS Voltage	2445	65027	GPAAC	V	1
Generator Phase A Line to Line AC RMS Voltage	2441	65027	GPAAC	V	1
Generator Phase A Real Power	2453	65026	GPAACP	W	1
Generator Phase A Apparent Power	2461	65026	GPAACP	VA	1
Generator Phase A Reactive Power	2457	65025	GPAACR	var	1
Generator Phase B AC RMS Current	2450	65024	GPBAC	A	1
Generator Phase B AC Frequency	2438	65024	GPBAC	Hz	128
Generator Phase B Line to Neutral AC RMS Voltage	2446	65024	GPBAC	V	1
Generator Phase B Line to Line AC RMS Voltage	2442	65024	GPBAC	V	1
Generator Phase B Real Power	2454	65023	GPBACP	W	1
Generator Phase B Apparent Power	2462	65023	GPBACP	VA	1
Generator Phase B Reactive Power	2458	65022	GPBACR	var	1
Generator Phase C AC RMS Current	2451	65021	GPCAC	A	1
Generator Phase C AC Frequency	2439	65021	GPCAC	Hz	128
Generator Phase C Line to Neutral AC RMS Voltage	2447	65021	GPCAC	V	1
Generator Phase C Line to Line AC RMS Voltage	2443	65021	GPCAC	V	1
Generator Phase C Real Power	2455	65020	GPCACP	W	1
Generator Phase C Apparent Power	2463	65020	GPCACP	VA	1
Generator Phase C Reactive Power	2459	65019	GPCACR	var	1
Generator Total Apparent Power	2460	65029	GTACP	W	1
Generator Total Real Power	2452	65029	GTACP	VA	1
Generator Overall Power Factor	2464	65028	GTACR	PF	1
Generator Overall Power Factor (Lead, Lag, Unity, Error flag)	2518	65028	GTACR	PF	1
Generator Total Reactive Power	2456	65028	GTACR	var	1
Generator Breaker Status	3545	64913	ACS	List 0-7	1
Mains Breaker Status	3546	64913	ACS	List 0-7	1
Generator Total Real Power (W)	3590	64911	GTACPP	%	1
Generator Control Not In Automatic	3567	64915	GC1	List 0-1	1

Breaker Status List

ACS Value	Description
0	Open
1	Closed
2	Locked
3	Reserved
4	Reserved
5	Reserved
6	Error
7	Reserved

Generator Control Not In Automatic Status List

GC1 Value	Description
0	In Automatic
1	Not in Automatic

2.10.9 DSENET® (EXPANSION MODULES)

▲ NOTE: For further details of module configuration, refer to DSE Publication: 057-238 *DSE8610 MKII Configuration Suite PC Software Manual*.

▲ NOTE: As a termination resistor is internally fitted to the controller, the controller must be the 'first' unit on the DSENet® link. A termination resistor **MUST** be fitted to the 'last' unit on the DSENet® link. For connection details, refer to section entitled *Typical Arrangement of DSENet®* elsewhere in this document.

▲ NOTE: DSE recommend Belden 9841 (or equivalent) cable for DSENet® communication. This is rated to a maximum cable length of 1.2 km. DSE Stock Belden 9841 cable, DSE Part Number: 016-030.

DSENet® is the interconnection cable between the host controller and the expansion module(s) and must not be connected to any device other than DSE equipment designed for connection to the DSENet®

Description	Specification
Cable Type	Two core screened and shielded twisted pair
Cable Characteristics	120 Ω Low capacitance
Recommended Cable	Belden 9841 Belden 9271
Maximum Cable Length	1200 m (¾ mile) when using Belden 9841 or direct equivalent. 600 m (656 yards) when using Belden 9271 or direct equivalent.
DSENet® Topology	"Daisy Chain" Bus with no stubs (spurs)
DSENet® Termination	120 Ω. Fitted internally to host controller. Must be fitted externally to the 'last' expansion module.
Maximum Expansion Modules	Total 20 devices made up of DSE2130 (up to 4), DSE2131 (up to 4), DSE2133 (up to 4), DSE2152 (up to 4), DSE2157 (up to 10), DSE2548 (up to 10) This gives the possibility of : Maximum 32 additional 0-10 V or 4-20 mA outputs (DSE2152) Maximum 80 additional relay outputs (DSE2157) Maximum 80 additional LED indicators Maximum 24 additional RTD or thermocouple inputs (DSE2133). Maximum 32 additional inputs (Can be configured as either digital, or resistive when using DSE2130) Maximum 40 additional flexible inputs (All can be configured as either digital, resistive, 0-10 V or 4-20 mA when using DSE2131)

2.10.9.1 DSENET® USED FOR MODBUS ENGINE CONNECTION

NOTE: For further details of module configuration, refer to DSE Publication: 057-238 *DSE8610 MKII Configuration Suite PC Software Manual*.

As DSENet® utilises an RS485 hardware interface, this port can be configured for connection to Cummins MODBUS engines (Engines fitted with Cummins GCS (G-Drive Control System)). This leaves the RS485 interface free for connection to remote monitoring equipment (i.e. Building Management System, PLC or PC RS485 port).

While this is a very useful feature in some applications, the obvious drawback is that the DSENet® interface is no longer available for connection to expansion devices.

Example of configuring the DSENet® for connection to Cummins QSK GCS using the DSE Configuration Suite Software:

The screenshot shows a configuration window titled "ECU (ECM) Options". It contains the following settings:

Option	Value
Engine Type	Cummins QSK
Enhanced J1939	<input type="checkbox"/>
Alternative Engine Speed	<input type="checkbox"/>
Modbus Engine Comms Port	DSENet Port

2.11 SOUNDER

The module features an internal sounder to draw attention to warning, electrical trip and shutdown alarms.

Description	Specification
Sounder Level	64 db at 1 m

2.11.1 ADDING AN EXTERNAL SOUNDER

Should an external alarm or indicator be required, this can be achieved by using the DSE Configuration Suite PC software to configure an auxiliary output for *Audible Alarm*, and by configuring an auxiliary input for *Alarm Mute* (if required).

The audible alarm output activates and de-activates at the same time as the module's internal sounder. The Alarm mute input and internal **Lamp Test / Alarm Mute**  button activate 'in parallel' with each other. Either signal mutes both the internal sounder and audible alarm output.

Example of configuration to achieve external sounder with external alarm mute button:

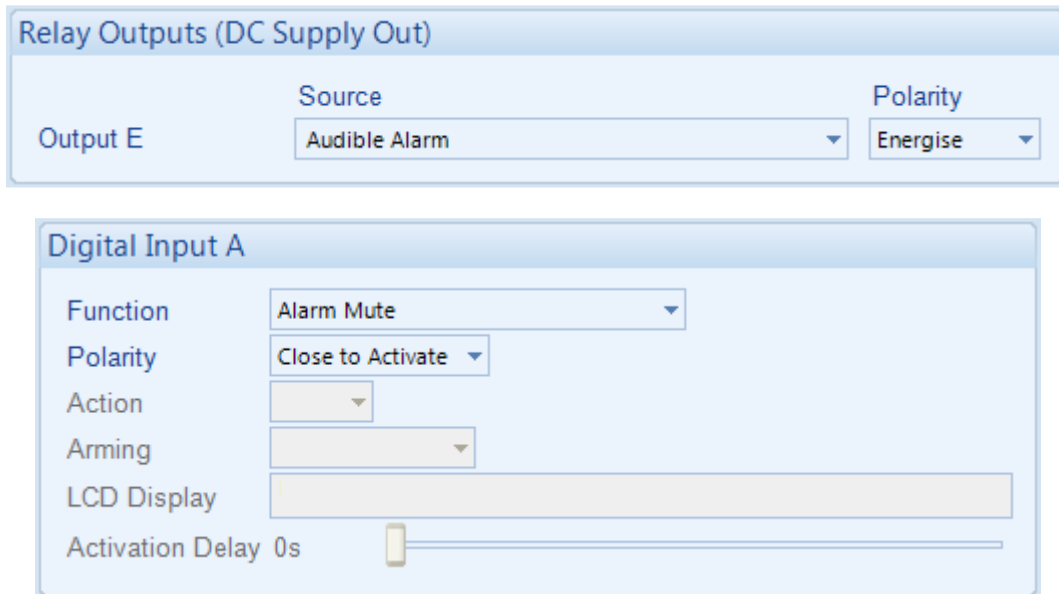

The screenshot shows two configuration windows. The top window, titled "Relay Outputs (DC Supply Out)", has a table with two columns: "Source" and "Polarity". Under "Source", "Output E" is set to "Audible Alarm". Under "Polarity", "Output E" is set to "Energise". The bottom window, titled "Digital Input A", has several settings: "Function" is "Alarm Mute", "Polarity" is "Close to Activate", "Action" is an empty dropdown, "Arming" is an empty dropdown, "LCD Display" is an empty text field, and "Activation Delay" is a slider set to "0s".

2.12 ACCUMULATED INSTRUMENTATION

NOTE: When an accumulated instrumentation value exceeds the maximum number as listed below, the value is reset and begins counting from zero again.

The number of logged *Engine Hours* and *Number of Starts* can be set/reset using the DSE Configuration Suite PC software. Depending upon module configuration, this may have been PIN number locked by the generator supplier.

Description	Specification
Engine Hours Run	Maximum 99999 hrs 59 minutes (Approximately 11yrs 4 months)
Number of Starts	1,000,000 (1 Million)
Accumulated Power	999999 kWh / kvarh / kVAh

2.13 DIMENSIONS AND MOUNTING

2.13.1 DIMENSIONS

245 mm x 184 mm x 51 mm
(9.6" x 7.2" x 2.0")

2.13.2 PANEL CUTOUT

220 mm x 159 mm
(8.7" x 6.3")

2.13.3 WEIGHT

0.98 kg
(2.16 lb)

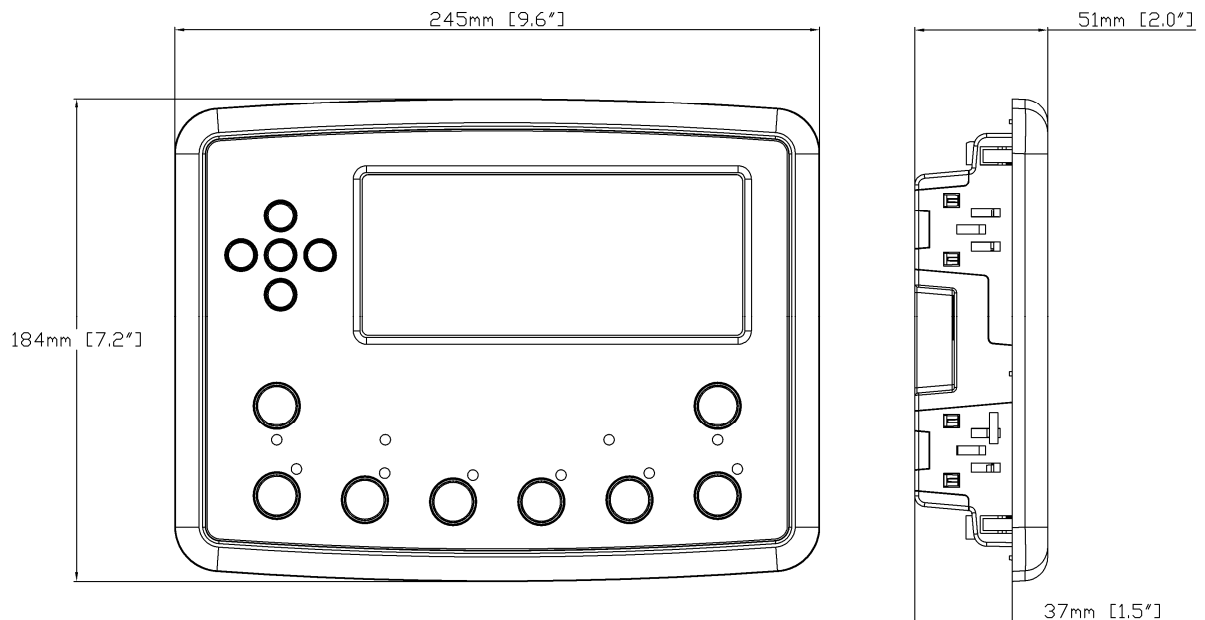

2.13.4 FIXING CLIPS

NOTE: In conditions of excessive vibration, mount the module on suitable anti-vibration mountings.

The module is held into the panel fascia using the supplied fixing clips.

Withdraw the fixing clip screw (turn anticlockwise) until only the pointed end is protruding from the clip.

Insert the three 'prongs' of the fixing clip into the slots in the side of the module case.

Pull the fixing clip backwards (towards the back of the module) ensuring all three prongs of the clip are inside their allotted slots.

Turn the fixing clip screws clockwise until they make contact with the panel fascia.

Turn the screw a quarter of a turn to secure the module into the panel fascia. Care must be taken not to over tighten the fixing clip screws.

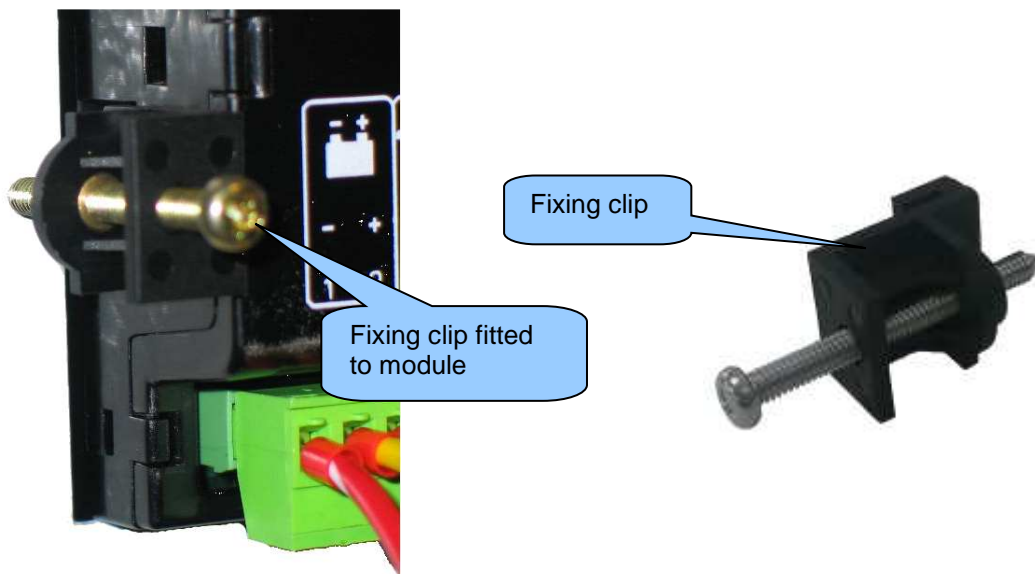

2.13.5 CABLE TIE FIXING POINTS

Cable tie fixing points are included on the rear of the module's case to aid wiring. This additionally provides strain relief to the cable loom by removing the weight of the loom from the screw connectors, reducing the chance of future connection failures.

Care must be taken not to over tighten the cable tie (for instance with cable tie tools) to prevent the risk of damage to the module case.



Cable Tie Fixing Point

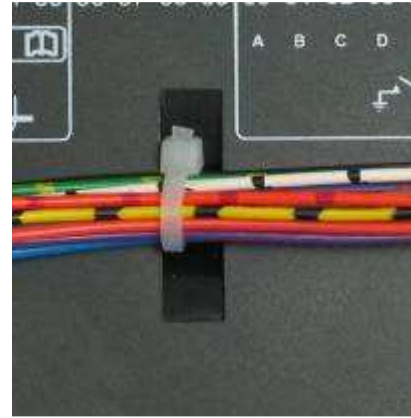

With Cable And Tie In Place

2.13.6 SILICON SEALING GASKET

NOTE: For purchasing a silicon gasket from DSE, see the section entitled **Maintenance, Spares, Repair and Servicing** elsewhere in this document.

The silicon gasket provides improved sealing between module and the panel fascia. The gasket is fitted to the module before installation into the panel fascia. Take care to ensure the gasket is correctly fitted to the module to maintain the integrity of the seal.

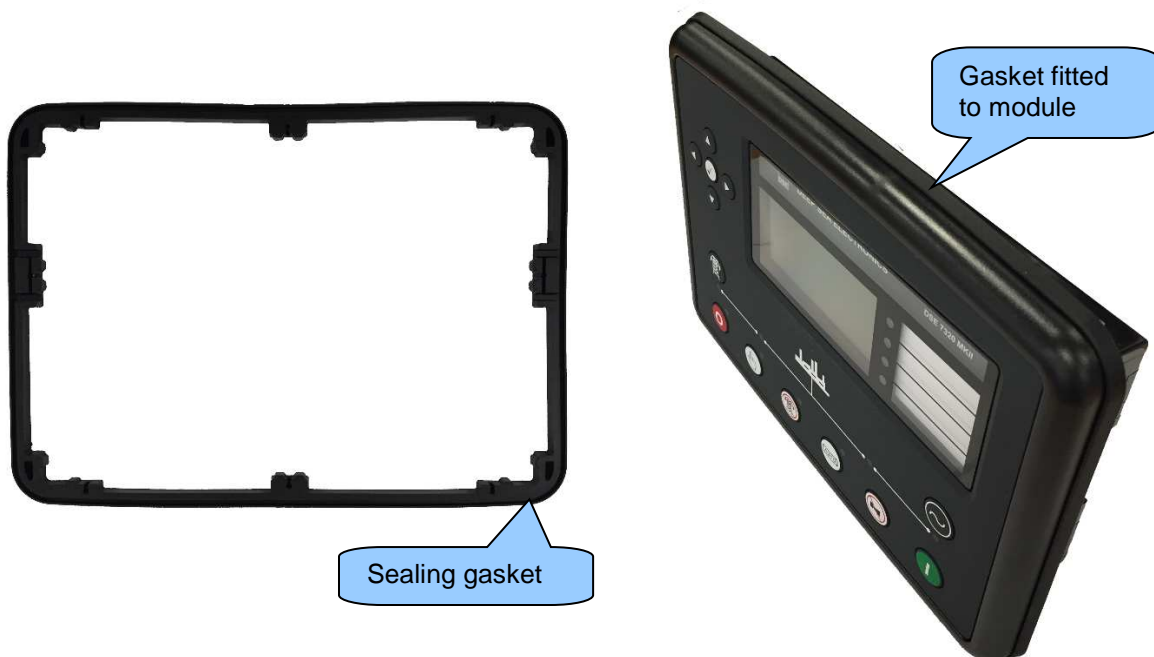

2.14 APPLICABLE STANDARDS

Standard	Description
BS 4884-1	This document conforms to BS4884-1 1992 Specification for presentation of essential information.
BS 4884-2	This document conforms to BS4884-2 1993 Guide to content
BS 4884-3	This document conforms to BS4884-3 1993 Guide to presentation
BS EN 60068-2-1 (Minimum temperature)	-30 °C (-22 °F)
BS EN 60068-2-2 (Maximum temperature)	+70 °C (158 °F)
BS EN 60950	Safety of information technology equipment, including electrical business equipment
BS EN 61000-6-2	EMC Generic Immunity Standard (Industrial)
BS EN 61000-6-4	EMC Generic Emission Standard (Industrial)
BS EN 60529 (Degrees of protection provided by enclosures)	IP65 (front of module when installed into the control panel with the optional sealing gasket) IP42 (front of module when installed into the control panel WITHOUT being sealed to the panel)
UL508 NEMA rating (Approximate)	12 (Front of module when installed into the control panel with the optional sealing gasket). 2 (Front of module when installed into the control panel WITHOUT being sealed to the panel)
IEEE C37.2 (Standard Electrical Power System Device Function Numbers and Contact Designations)	<p>Under the scope of IEEE 37.2, function numbers can also be used to represent functions in microprocessor devices and software programs. The controller is device number 11L-8000 (Multifunction device protecting Line (generator) –module).</p> <p>As the module is configurable by the generator OEM, the functions covered by the module vary. Depending on module configuration, the device numbers included within the module could be:</p> <ul style="list-style-type: none"> 2 – Time delay starting or closing relay 3 – Checking or interlocking relay 5 – Stopping device 6 – Starting circuit breaker 8 – Control power disconnecting device 10 – Unit sequence switch 11 – Multifunction device 12 – Overspeed device 14 – Underspeed device 15 – Speed or frequency matching device. 23 – Temperature control device 25 – Synchronising or synchronism check relay 26 – Apparatus thermal device 27AC – AC undervoltage relay 27DC – DC undervoltage relay 29 – Isolating contactor or switch 30 – Annunciator relay 31 – Separate Excitation Device 37 – Undercurrent or underpower relay (USING INTERNAL PLC EDITOR) 41 – Field circuit breaker 42 – Running circuit breaker 44 – Unit sequence relay

Continued over the page...

Specification

Standard	Description
IEEE C37.2 (Standard Electrical Power System Device Function Numbers and Contact Designations)	Continued... 46 – Reverse-phase or phase-balance current relay 48 – Incomplete sequence relay 49 – Machine or transformer thermal relay 50 – Instantaneous overcurrent relay 51 – AC time overcurrent relay 52 – AC circuit breaker 53 – Exciter or DC generator relay 54 – Turning gear engaging device 55 – Power factor relay (USING INTERNAL PLC EDITOR) 59AC – AC overvoltage relay 59DC – DC overvoltage relay 62 – Time delay stopping or opening relay 63 – Pressure switch 71 – Level switch 74 – Alarm relay 78 – Phase-angle measuring relay 79 – Reclosing relay (USING INTERNAL PLC EDITOR) 81 – Frequency relay 83 – Automatic selective control or transfer relay 86 – Lockout relay

In line with our policy of continual development, Deep Sea Electronics, reserve the right to change specification without notice.

2.14.1 ENCLOSURE CLASSIFICATIONS

2.14.1.1 IP CLASSIFICATIONS

The modules specification under BS EN 60529 Degrees of protection provided by enclosures

IP65 (Front of module when module is installed into the control panel with the optional sealing gasket).
IP42 (front of module when module is installed into the control panel WITHOUT being sealed to the panel)

First Digit	Second Digit
Protection against contact and ingress of solid objects	Protection against ingress of water
0 No protection	0 No protection
1 Protected against ingress solid objects with a diameter of more than 50 mm. No protection against deliberate access, e.g. with a hand, but large surfaces of the body are prevented from approach.	1 Protection against dripping water falling vertically. No harmful effect must be produced (vertically falling drops).
2 Protected against penetration by solid objects with a diameter of more than 12 mm. Fingers or similar objects prevented from approach.	2 Protection against dripping water falling vertically. There must be no harmful effect when the equipment (enclosure) is tilted at an angle up to 15° from its normal position (drops falling at an angle).
3 Protected against ingress of solid objects with a diameter of more than 2.5 mm. Tools, wires etc. with a thickness of more than 2.5 mm are prevented from approach.	3 Protection against water falling at any angle up to 60° from the vertical. There must be no harmful effect (spray water).
4 Protected against ingress of solid objects with a diameter of more than 1 mm. Tools, wires etc. with a thickness of more than 1 mm are prevented from approach.	4 Protection against water splashed against the equipment (enclosure) from any direction. There must be no harmful effect (splashing water).
5 Protected against harmful dust deposits. Ingress of dust is not totally prevented but the dust must not enter in sufficient quantity to interface with satisfactory operation of the equipment. Complete protection against contact.	5 Protection against water projected from a nozzle against the equipment (enclosure) from any direction. There must be no harmful effect (water jet).
6 Protection against ingress of dust (dust tight). Complete protection against contact.	6 Protection against heavy seas or powerful water jets. Water must not enter the equipment (enclosure) in harmful quantities (splashing over).

2.14.1.2 NEMA CLASSIFICATIONS

 NOTE: There is no direct equivalence between IP / NEMA ratings. IP figures shown are approximate only.

12 (Front of module when module is installed into the control panel with the optional sealing gasket).
2 (Front of module when module is installed into the control panel WITHOUT being sealed to the panel)

1 IP30	Provides a degree of protection against contact with the enclosure equipment and against a limited amount of falling dirt.
2 IP31	Provides a degree of protection against limited amounts of falling water and dirt.
3 IP64	Provides a degree of protection against windblown dust, rain and sleet; undamaged by the formation of ice on the enclosure.
3R IP32	Provides a degree of protection against rain and sleet;; undamaged by the formation of ice on the enclosure.
4 (X) IP66	Provides a degree of protection against splashing water, windblown dust and rain, hose directed water; undamaged by the formation of ice on the enclosure. (Resist corrosion).
12/12K IP65	Provides a degree of protection against dust, falling dirt and dripping non corrosive liquids.
13 IP65	Provides a degree of protection against dust and spraying of water, oil and non corrosive coolants.

3 INSTALLATION

The module is designed to be mounted on the panel fascia. For dimension and mounting details, see the section entitled *Dimension and Mounting* elsewhere in this document.

3.1 USER CONNECTIONS

NOTE: Availability of some terminals depends upon module version. Full details are given in the section entitled *Terminal Description* elsewhere in this manual.

To aid user connection, icons are used on the rear of the module to help identify terminal functions. An example of this is shown below.

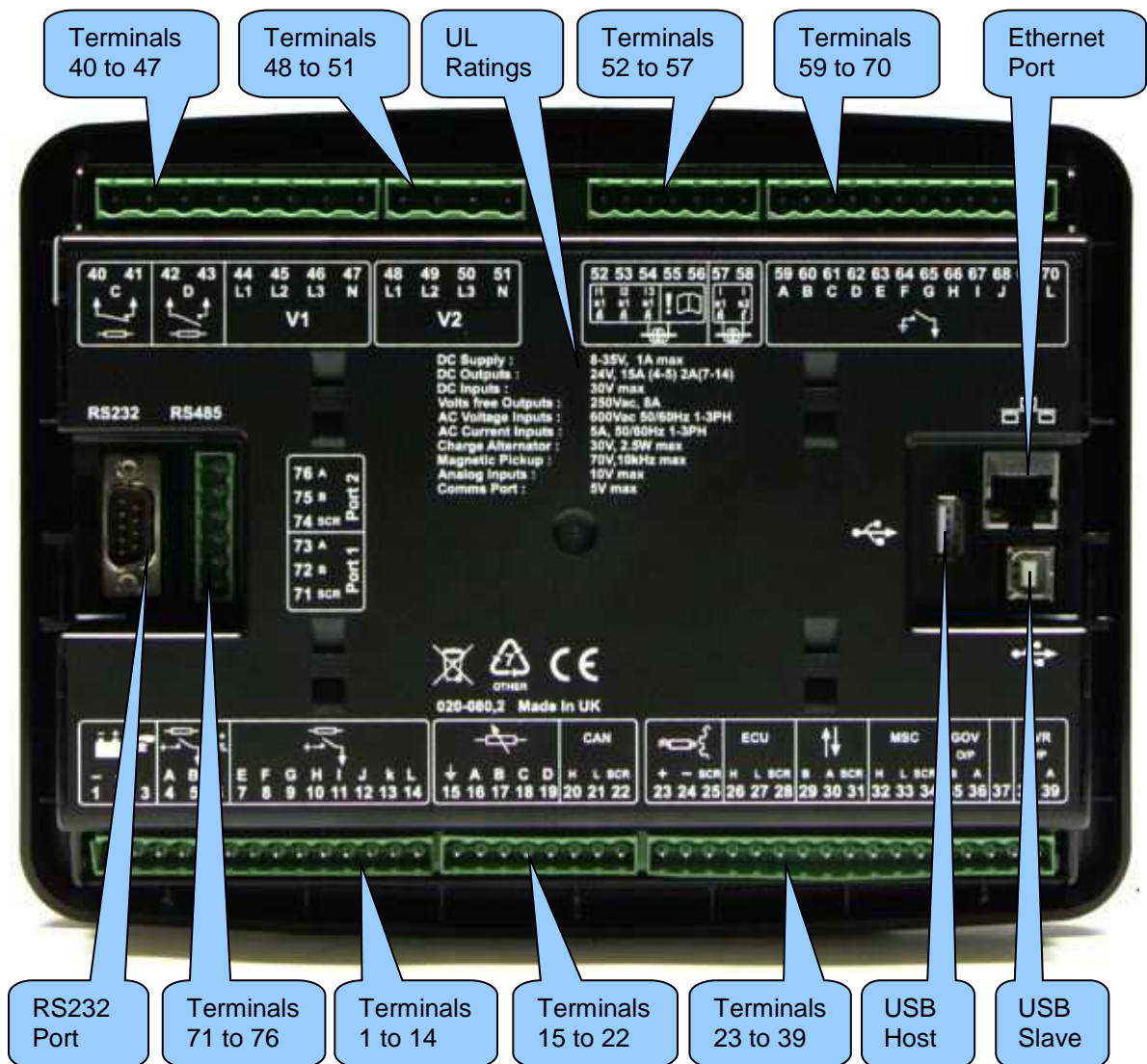





3.2 CONNECTION DESCRIPTIONS

3.2.1 DC SUPPLY, E-STOP INPUT, DC OUTPUTS & CHARGE FAIL INPUT

 **NOTE:** When the module is configured for operation with an electronic engine, *Fuel* and *Start* output requirements may be different. For further details on connection to electronic engines, refer to DSE Publication: *057-004 Electronic Engines And DSE Wiring*

 **NOTE:** For further details of module configuration, refer to DSE Publication: *057-238 DSE8610 MKII Configuration Suite PC Software Manual*.

	Pin No	Description	Cable Size	Notes
	1	DC Plant Supply Input (Negative)	2.5 mm ² AWG 13	Connect to ground where applicable.
	2	DC Plant Supply Input (Positive)	2.5 mm ² AWG 13	Supplies the module and DC Outputs E, F, G, H, I & J
	3	Emergency Stop Input	2.5 mm ² AWG 13	Plant Supply Positive. Supplies DC Outputs A & B.
	4	DC Output A (FUEL)	2.5 mm ² AWG 13	Plant Supply Positive from terminal 3. 15 A DC rated Fixed as fuel relay if electronic engine is not configured.
	5	DC Output B (START)	2.5 mm ² AWG 13	Plant Supply Positive from terminal 3. 15 A DC rated Fixed as start relay if electronic engine is not configured.
D+ W/L	6	Charge Fail / Excite	2.5 mm ² AWG 13	Do not connect to ground (battery negative). If charge alternator is not fitted, leave this terminal disconnected.
	7	DC Output E	1.0 mm ² AWG 18	Plant Supply Positive from terminal 2. 2 A DC rated.
	8	DC Output F	1.0 mm ² AWG 18	Plant Supply Positive from terminal 2. 2 A DC rated.
	9	DC Output G	1.0 mm ² AWG 18	Plant Supply Positive from terminal 2. 2 A DC rated.
	10	DC Output H	1.0 mm ² AWG 18	Plant Supply Positive from terminal 2. 2 A DC rated.
	11	DC Output I	1.0 mm ² AWG 18	Plant Supply Positive from terminal 2. 2 A DC rated.
	12	DC Output J	1.0 mm ² AWG 18	Plant Supply Positive from terminal 2. 2 A DC rated.
	13	DC Output K	1.0 mm ² AWG 18	Plant Supply Positive from terminal 2. 2 A DC rated.
	14	DC Output L	1.0 mm ² AWG 18	Plant Supply Positive from terminal 2. 2 A DC rated.

3.2.2 ANALOGUE SENSOR INPUTS & CAN

 **NOTE:** For further details of module configuration, refer to DSE Publication: 057-238 *DSE8610 MKII Configuration Suite PC Software Manual*.

 **NOTE:** It is VERY important that terminal 15 (sensor common) is connected to an earth point on the ENGINE BLOCK, not within the control panel, and must be a sound electrical connection to the sensor bodies. This connection **MUST NOT** be used to provide an earth connection for other terminals or devices. The simplest way to achieve this is to run a **SEPARATE** earth connection from the system earth star point, to terminal 15 directly, and not use this earth for other connections.

 **NOTE:** If PTFE insulating tape is used on the sensor thread when using earth return sensors, ensure not to insulate the entire thread, as this prevents the sensor body from being earthed via the engine block.

 **NOTE:** Screened 120 Ω impedance cable specified for use with CAN must be used for the CAN & MSC links.
DSE stock and supply Belden cable 9841 which is a high quality 120 Ω impedance cable suitable for CAN use (DSE part number 016-030)

	Pin No	Description	Cable Size	Notes
	15	Sensor Common Return	0.5 mm ² AWG 20	Ground Return Feed For Sensors
	16	Analogue Sensor Input A	0.5 mm ² AWG 20	Connect To Oil Pressure Sensor
	17	Analogue Sensor Input B	0.5mm ² AWG 20	Connect To Coolant Temperature Sensor
	18	Analogue Sensor Input C	0.5 mm ² AWG 20	Connect To Fuel Level Sensor
	19	Analogue Sensor Input D	0.5 mm ² AWG 20	Connect To Additional Sensor (User Configurable)
CAN	20	CAN Port H	0.5 mm ² AWG 20	Use only 120 Ω CAN or RS485 approved cable
	21	CAN Port L	0.5 mm ² AWG 20	Use only 120 Ω CAN or RS485 approved cable
	22	CAN Port Screen	Shield	Use only 120 Ω CAN or RS485 approved cable



3.2.3 MPU, ECU, MSC & DSENET®

NOTE: For further details of module configuration, refer to DSE Publication: 057-238 *DSE8610 MKII Configuration Suite PC Software Manual*.

NOTE: For further details on connection to electronic engines, refer to DSE Publication: 057-004 *Electronic Engines And DSE Wiring*



NOTE: Screened 120 Ω impedance cable specified for use with CAN must be used for the CAN & MSC links.
DSE stock and supply Belden cable 9841 which is a high quality 120 Ω impedance cable suitable for CAN use (DSE part number 016-030)

NOTE: As a termination resistor is internally fitted to the controller, the controller must be the 'first' unit on the DSENet® link. A termination resistor **MUST** be fitted to the 'last' unit on the DSENet® link. For connection details, refer to section entitled *Typical Wiring Diagram* elsewhere in this document.

	Pin No	Description	Cable Size	Notes
	23	Magnetic Pickup Positive	0.5 mm ² AWG 20	Connect To Magnetic Pickup Device
	24	Magnetic Pickup Negative	0.5 mm ² AWG 20	Connect To Magnetic Pickup Device
	25	Magnetic Pickup Screen	Shield	Connect To Ground At One End Only
ECU	26	ECU Port H	0.5 mm ² AWG 20	Use only 120 Ω CAN or RS485 approved cable
	27	ECU Port L	0.5 mm ² AWG 20	Use only 120 Ω CAN or RS485 approved cable
	28	ECU Port Screen	Shield	Use only 120 Ω CAN or RS485 approved cable
	29	DSENet® Expansion B	0.5 mm ² AWG 20	Use only 120 Ω CAN or RS485 approved cable
	30	DSENet® Expansion A	0.5 mm ² AWG 20	Use only 120 Ω CAN or RS485 approved cable
	31	DSENet® Expansion Screen	Shield	Use only 120 Ω CAN or RS485 approved cable
MSC	32	MSC Port H	0.5 mm ² AWG 20	Use only 120 Ω CAN or RS485 approved cable
	33	MSC Port L	0.5 mm ² AWG 20	Use only 120 Ω CAN or RS485 approved cable
	34	MSC Port Screen	Shield	Use only 120 Ω CAN or RS485 approved cable
GOV	35	Analogue Governor Output B	0.5mm ² AWG 20	Analogue Governor DC Output
	36	Analogue Governor Output A	0.5mm ² AWG 20	Analogue Governor Output Reference
		DO NOT CONNECT		DO NOT CONNECT
AVR	38	Analogue AVR Output B	0.5mm ² AWG 20	Analogue AVR DC Output
	39	Analogue AVR Output A	0.5mm ² AWG 20	Analogue AVR Output Reference

3.2.4 OUTPUT C & D & V1 (GENERATOR) VOLTAGE & FREQUENCY SENSING

NOTE: The below table describes connections to a three phase, four wire alternator. For alternative wiring topologies, see the section entitled *Alternate Topology Wiring Diagrams* elsewhere in this document.

	Pin No	Description	Cable Size	Notes
	40	Normally Closed Volt-Free Relay Output C	1.0mm ² AWG 18	Normally configured to open the generator contactor coil
	41		1.0mm ² AWG 18	
	42	Normally Open Volt-Free Relay Output D	1.0mm ² AWG 18	Normally configured to close the generator contactor coil
	43		1.0mm ² AWG 18	
V1	44	Generator L1 (U) Voltage Sensing	1.0 mm ² AWG 18	Connect to generator L1 (U) output (AC) (Recommend 2 A fuse)
	45	Generator L2 (V) Voltage Sensing	1.0 mm ² AWG 18	Connect to generator L2 (V) output (AC) (Recommend 2 A fuse)
	46	Generator L3 (W) Voltage Sensing	1.0 mm ² AWG 18	Connect to generator L3 (W) output (AC) (Recommend 2 A fuse)
	47	Generator Neutral (N) Input	1.0 mm ² AWG 18	Connect to generator Neutral terminal (AC)

3.2.5 V2 (BUS) VOLTAGE & FREQUENCY SENSING

NOTE: The below table describes connections to a three phase, four wire Bus supply. For alternative wiring topologies, see the section entitled *Alternate Topology Wiring Diagrams* elsewhere in this document.

	Pin No	Description	Cable Size	Notes
V2	48	Bus L1 (R) Voltage Sensing	1.0 mm ² AWG 18	Connect to Bus L1 (R) output (AC) (Recommend 2 A fuse)
	49	Bus L2 (S) Voltage Sensing	1.0 mm ² AWG 18	Connect to Bus L2 (S) output (AC) (Recommend 2 A fuse)
	50	Bus L3 (T) Voltage Sensing	1.0 mm ² AWG 18	Connect to Bus L3 (T) output (AC) (Recommend 2 A fuse)
	51	Bus Neutral (N) Input	1.0 mm ² AWG 18	Connect to Bus Neutral terminal (AC)

3.2.6 CURRENT TRANSFORMERS

 **WARNING!** Do not disconnect this plug when the CTs are carrying current. Disconnection open circuits the secondary of the C.T.'s and dangerous voltages may then develop. Always ensure the CTs are not carrying current and the CTs are short circuit connected before making or breaking connections to the module.

 **NOTE:** The module has a burden of 0.25 VA on the CT. Ensure the CT is rated for the burden of the controller, the cable length being used and any other equipment sharing the CT. If in doubt, consult with the CT supplier.

 **NOTE:** Take care to ensure correct polarity of the CT primary as shown below. If in doubt, consult with the CT supplier.

 **NOTE:** Terminals 57 & 58 are not fitted, do not connect.

	Pin No	Description	Cable Size	Notes
	52	CT Secondary for L1	2.5 mm ² AWG 13	Connect to s1 secondary of L1 monitoring CT
	53	CT Secondary for L2	2.5 mm ² AWG 13	Connect to s1 secondary of L2 monitoring CT
	54	CT Secondary for L3	2.5 mm ² AWG 13	Connect to s1 secondary of L3 monitoring CT

 **NOTE:** The function of terminals 45 and 46 changes depending upon what type of earth fault protection (if any) is being used:

	Topology	Pin No	Notes	Cable Size
	No earth fault measuring	55	DO NOT CONNECT	
		56	Connect to s2 of the CTs connected to L1,L2,L3,N	2.5mm ² AWG 13
	Restricted earth fault measuring	55	Connect to s2 of the CTs connected to L1,L2,L3,N	2.5mm ² AWG 13
		56	Connect to s1 of the CT on the neutral conductor	2.5mm ² AWG 13
	Un-restricted earth fault measuring (Earth fault CT is fitted in the neutral to earth link)	55	Connect to s2 of the CT on the neutral to earth link.	2.5mm ² AWG 13
		56	Connect to s1 of the CT on the neutral to earth link. Also connect to the s2 of CTs connected to L1, L2, L3.	2.5mm ² AWG 13

3.2.6.1 CT CONNECTIONS

p1, κ or K is the primary of the CT that 'points' towards the Generator

p2, ℓ or L is the primary of the CT that 'points' towards the Load

s1 is the secondary of the CT that connects to the DSE Module's input for the CT measuring

s2 is the secondary of the CT that should be commoned with the s2 connections of all the other CTs and connected to the CT common terminal of the module.

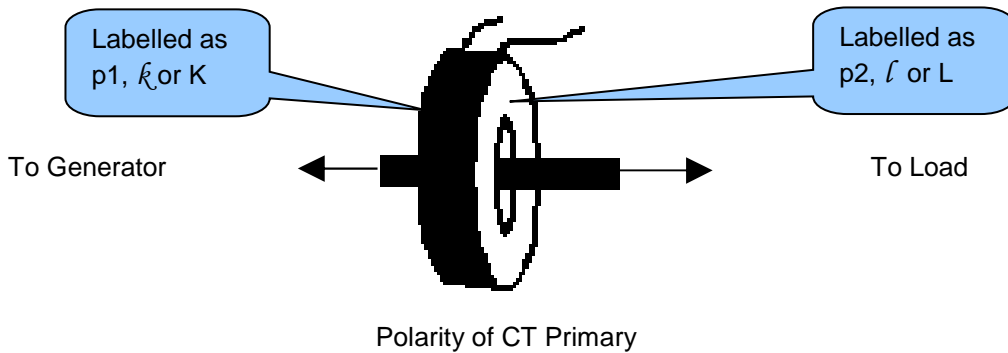

3.2.7 DIGITAL INPUTS

NOTE: For further details of module configuration, refer to DSE Publication: 057-238 *DSE8610 MKII Configuration Suite PC Software Manual*.

Pin No	Description	Cable Size	Notes
59	Configurable Digital Input A	0.5 mm ² AWG 20	Switch To Negative
60	Configurable Digital Input B	0.5 mm ² AWG 20	Switch To Negative
61	Configurable Digital Input C	0.5 mm ² AWG 20	Switch To Negative
62	Configurable Digital Input D	0.5 mm ² AWG 20	Switch To Negative
63	Configurable Digital Input E	0.5 mm ² AWG 20	Switch To Negative
64	Configurable Digital Input F	0.5 mm ² AWG 20	Switch To Negative
65	Configurable Digital Input G	0.5 mm ² AWG 20	Switch To Negative
66	Configurable Digital Input H	0.5 mm ² AWG 20	Switch To Negative
67	Configurable Digital Input I	0.5 mm ² AWG 20	Switch To Negative
68	Configurable Digital Input J	0.5 mm ² AWG 20	Switch To Negative
69	Configurable Digital Input K	0.5 mm ² AWG 20	Switch To Negative
70	Configurable Digital Input L	0.5 mm ² AWG 20	Switch To Negative

3.2.8 RS485

NOTE: For further details of module configuration, refer to DSE Publication: 057-238 *DSE8610 MKII Configuration Suite PC Software Manual*.

NOTE: A 120 Ω termination resistor must be fitted across terminals A and B if the DSE module is the first or last device on the R485 link.

NOTE: Screened 120 Ω impedance cable specified for use with RS485 must be used for the RS485 link.
DSE stock and supply Belden cable 9841 which is a high quality 120 Ω impedance cable suitable for CAN use (DSE part number 016-030)

	Pin No	Description	Cable Size	Notes
RS485 1	71	RS485 Port Screen	Shield	Use only 120 Ω CAN or RS485 approved cable
	72	RS485 Port B (+)	0.5 mm ² AWG 20	Connect to RXD+ and TXD+ Use only 120 Ω CAN or RS485 approved cable
	73	RS485 Port A (-)	0.5 mm ² AWG 20	Connect to RXD- and TXD- Use only 120 Ω CAN or RS485 approved cable
RS485 2	74	RS485 Port Screen	Shield	Use only 120 Ω CAN or RS485 approved cable
	75	RS485 Port B (+)	0.5 mm ² AWG 20	Connect to RXD+ and TXD+ Use only 120 Ω CAN or RS485 approved cable
	76	RS485 Port A (-)	0.5 mm ² AWG 20	Connect to RXD- and TXD- Use only 120 Ω CAN or RS485 approved cable

3.2.9 RS232

NOTE: For further details of module configuration, refer to DSE Publication: 057-238 *DSE8610 MKII Configuration Suite PC Software Manual.*

Description	Notes
 <p>Socket for connection to a modem or PC with DSE Configuration Suite Software</p>	Supports MODBUS RTU protocol or external modem

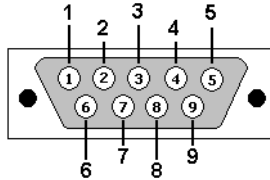

View looking into the male connector on the module



PIN No	Notes
1	Received Line Signal Detector (Data Carrier Detect)
2	Received Data
3	Transmit Data
4	Data Terminal Ready
5	Signal Ground
6	Data Set Ready
7	Request To Send
8	Clear To Send
9	Ring Indicator

3.2.10 USB SLAVE (PC CONFIGURATION) CONNECTOR

NOTE: The USB connection cable between the PC and the module must not be extended beyond 5 m (yards). For distances over 5 m, it is possible to use a third party USB extender. Typically, they extend USB up to 50 m. The supply and support of this type of equipment is outside the scope of Deep Sea Electronics PLC.

CAUTION! Care must be taken not to overload the PC's USB system by connecting more than the recommended number of USB devices to the PC. For further information, consult your PC supplier.

NOTE: For further details of module configuration, refer to DSE Publication: 057-238 *DSE8610 MKII Configuration Suite PC Software Manual*.

	Description	Cable Size	Notes
	Socket for connection to PC with DSE Configuration Suite Software	0.5 mm ² AWG 20	This is a standard USB type A to type B connector. 

3.2.11 USB HOST (DATA LOGGING) CONNECTOR

NOTE: For further details of module configuration, refer to DSE Publication: 057-238 *DSE8610 MKII Configuration Suite PC Software Manual*.

NOTE: For further details on how to add and remove a USB storage device, refer to section entitled *Data Logging Pages* elsewhere in this document.

	Description	Storage Size	Notes
	Socket for connection to USB storage device for data logging	Maximum 16 GB	USB storage device must be formatted as FAT, not FAT32.

3.3 TYPICAL WIRING DIAGRAM

As every system has different requirements, these diagrams show only a typical system and do not intend to show a complete system.

Genset manufacturers and panel builders may use these diagrams as a starting point; however always refer to the completed system diagram provided by the system manufacturer for complete wiring detail.

Further wiring suggestions are available in the following DSE publications, available at www.deepseapl.com to website members.

DSE Part	Description
056-022	Breaker Control (Training guide)
057-004	Electronic Engines and DSE Wiring

3.3.1 (3 PHASE 4 WIRE) WITH RESTRICTED EARTH FAULT

NOTE: The below diagram is applicable for the following AC topologies: 3 Phase 4 Wire Star, 3 Phase 4 Wire Delta L1-N-L2, 3 Phase 4 Wire Delta L1-N-L3 and 3 Phase 4 Wire Delta L2-N-L3. For further details of module configuration to suit these different topologies, refer to DSE Publication: 057-238 DSE8610 MKII Configuration Suite PC Software Manual.

NOTE: Earthing the neutral conductor 'before' the neutral CT allows the module to read earth faults 'after' the CT only (Restricted to load / downstream of the CT)
 Earthing the neutral conductor 'after' the neutral CT allows the module to read earth faults 'before' the CT only (Restricted to generator / upstream of the CT)

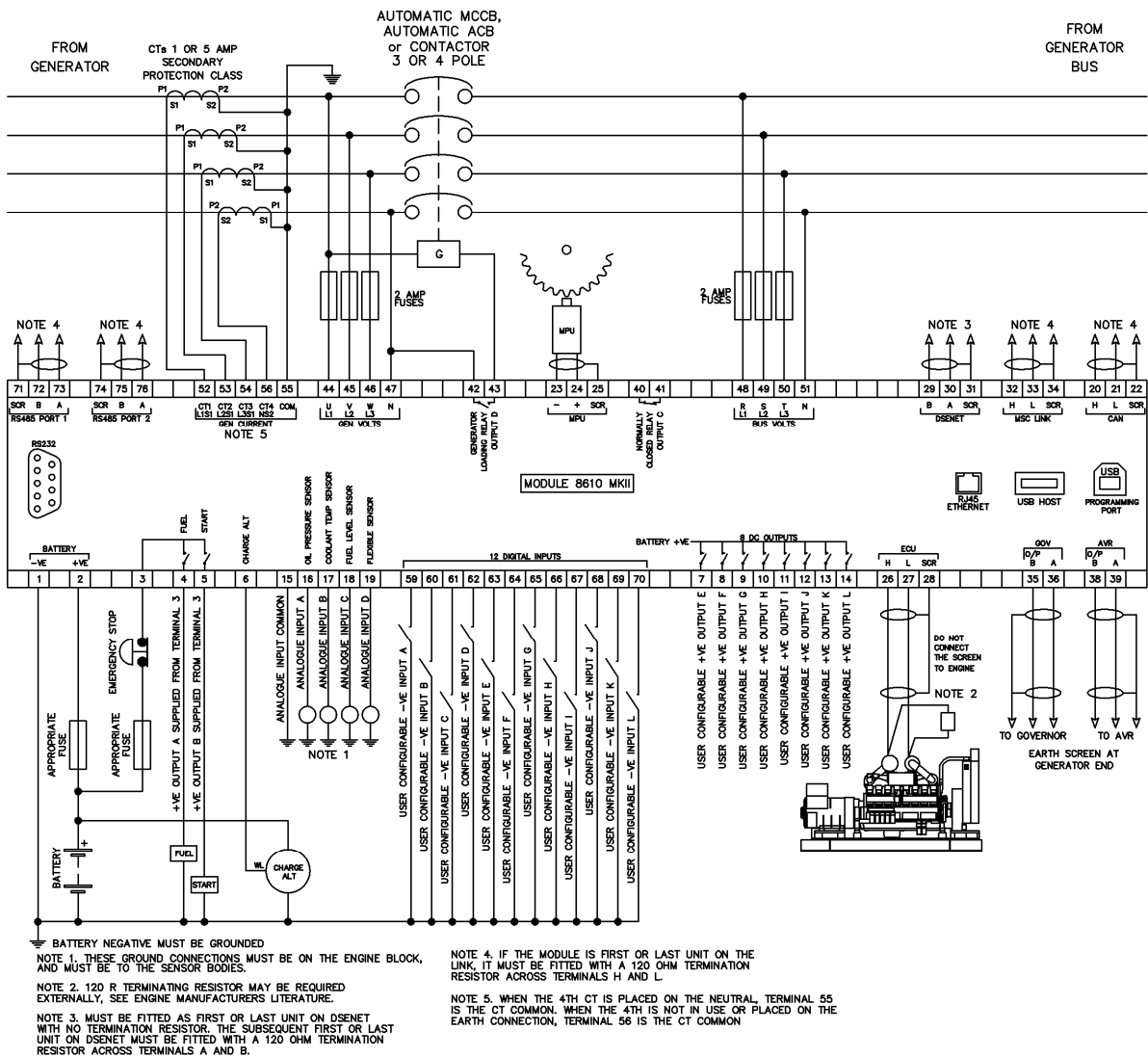

3.3.2 EARTH SYSTEMS

3.3.2.1 NEGATIVE EARTH

The typical wiring diagrams located within this document show connections for a negative earth system (the battery negative connects to Earth).

3.3.2.2 POSITIVE EARTH

When using a DSE module with a Positive Earth System (the battery positive connects to Earth), the following points must be followed:

Follow the typical wiring diagram as normal for all sections **except** the earth points. All points shown as Earth on the typical wiring diagram should connect to **battery negative** (not earth).

3.3.2.3 FLOATING EARTH

Where neither the battery positive nor battery negative terminals are connected to earth the following points must to be followed:

Follow the typical wiring diagram as normal for all sections **except** the earth points. All points shown as Earth on the typical wiring diagram should connect to **battery negative** (not earth).

3.3.3 TYPICAL ARRANGEMENT OF DSENET®

NOTE: For further details of module configuration, refer to DSE Publication: 057-238 *DSE8610 MKII Configuration Suite PC Software Manual*.

NOTE: This feature is not available if the DSE86xx MKII module has been configured to use the DSENet® port as the interface to a Cummins MODBUS GCS ECU.

NOTE: Screened 120 Ω impedance cable specified for use with CAN must be used for the DSENet® (RS485) connection.

DSE stock and supply Belden cable 9841 which is a high quality 120Ω impedance cable suitable for DSENet® use (DSE part number 016-030)

Twenty (20) devices can be connected to the DSENet®, made up of the following devices :

Device	Maximum Number Supported
DSE2130 Input Expansion	4
DSE2131 Input Expansion	4
DSE2133 Input Expansion	4
DSE2152 Relay Output Expansion	4
DSE2157 Relay Output Expansion	10
DSE2548 LED Expansion	10

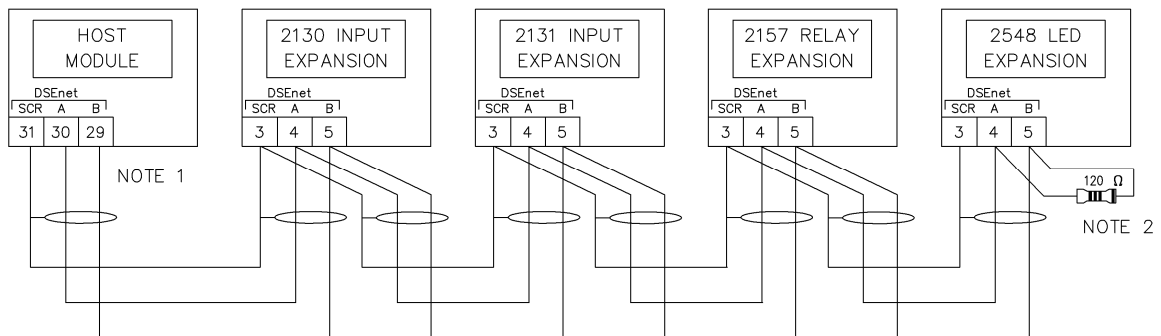

NOTE 1
AS A TERMINATING RESISTOR IS INTERNALLY FITTED TO THE HOST CONTROLLER, THE HOST CONTROLLER MUST BE THE FIRST UNIT ON THE DSEnet

NOTE 2
A 120 OHM TERMINATION RESISTOR MUST BE FITTED TO THE LAST UNIT ON THE DSEnet

3.3.4 TYPICAL ARRANGEMENT OF MSC LINK

NOTE: For further details of module configuration, refer to DSE Publication: 057-238 *DSE8610 MKII Configuration Suite PC Software Manual*.

NOTE: Screened 120 Ω impedance cable specified for use with CAN must be used for the DSENet® (RS485) connection.

DSE stock and supply Belden cable 9841 which is a high quality 120Ω impedance cable suitable for DSENet® use (DSE part number 016-030)

NOTE: A termination resistor **MUST** be fitted to the first and last unit on the MSC link.

NOTE: If any number of DSE8x60 are on the MSC link, a maximum of 2x DSE8x80 can be used. For each DSE8x80 used, the number of available DSE8x60s to be used reduces.

Total of 40 DSE modules can be connected to the MSC link made up of DSE8x10 (up to 32), DSE8x60 (up to 16) and DSE8x80 (up to 16)

This gives the possibility of:

- 32 generators (DSE8x10) and 8 synchronising transfers (DSE8x60)
- 32 generators (DSE8x10) and 8 generator bus couplers (DSE8x80)
- 24 generators (DSE8x10) and 16 synchronising transfers (DSE8x60)
- 24 generators (DSE8x10) and 16 generator bus couplers (DSE8x80)
- 32 generators (DSE8x10), **14** synchronising transfers (DSE8x60) and **2** generator bus couplers (DSE8x80)

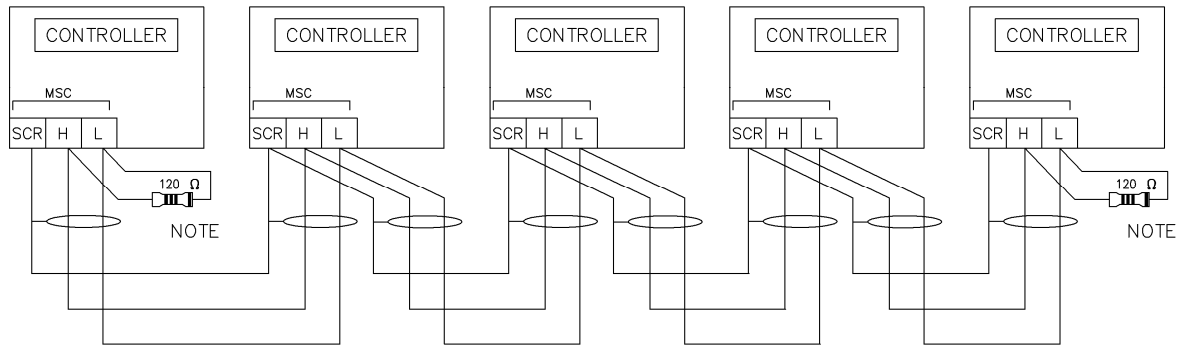

NOTE
A 120 OHM TERMINATION RESISTOR MUST BE FITTED TO THE FIRST AND LAST UNIT ON THE MSC LINK

3.4 ALTERNATE TOPOLOGY WIRING DIAGRAMS

3.4.1 SINGLE PHASE (L1 & N) 2 WIRE WITH RESTRICTED EARTH FAULT

NOTE: Earthing the neutral conductor 'before' the neutral CT allows the module to read earth faults 'after' the CT only (Restricted to load / downstream of the CT)
 Earthing the neutral conductor 'after' the neutral CT allows the module to read earth faults 'before' the CT only (Restricted to generator / upstream of the CT)

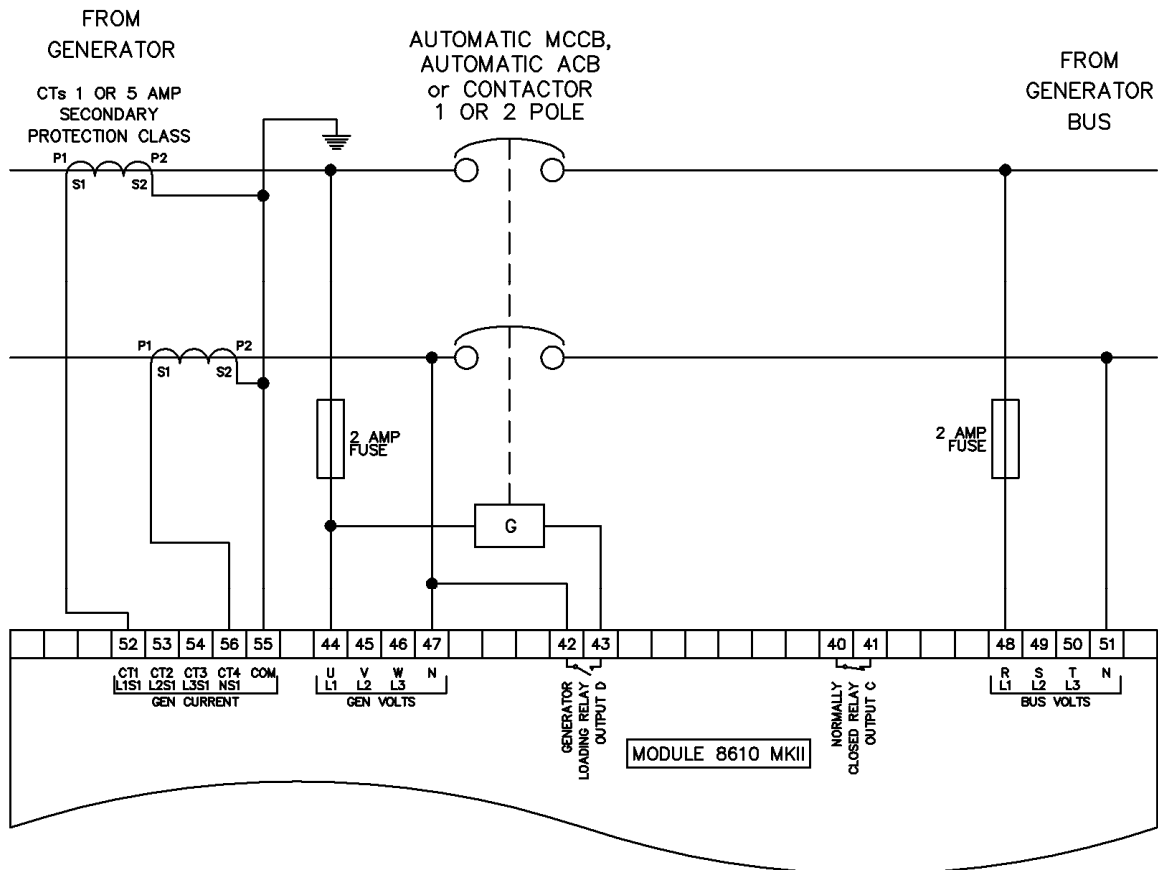

3.4.2 SINGLE PHASE (L1 & N) 2 WIRE WITHOUT EARTH FAULT

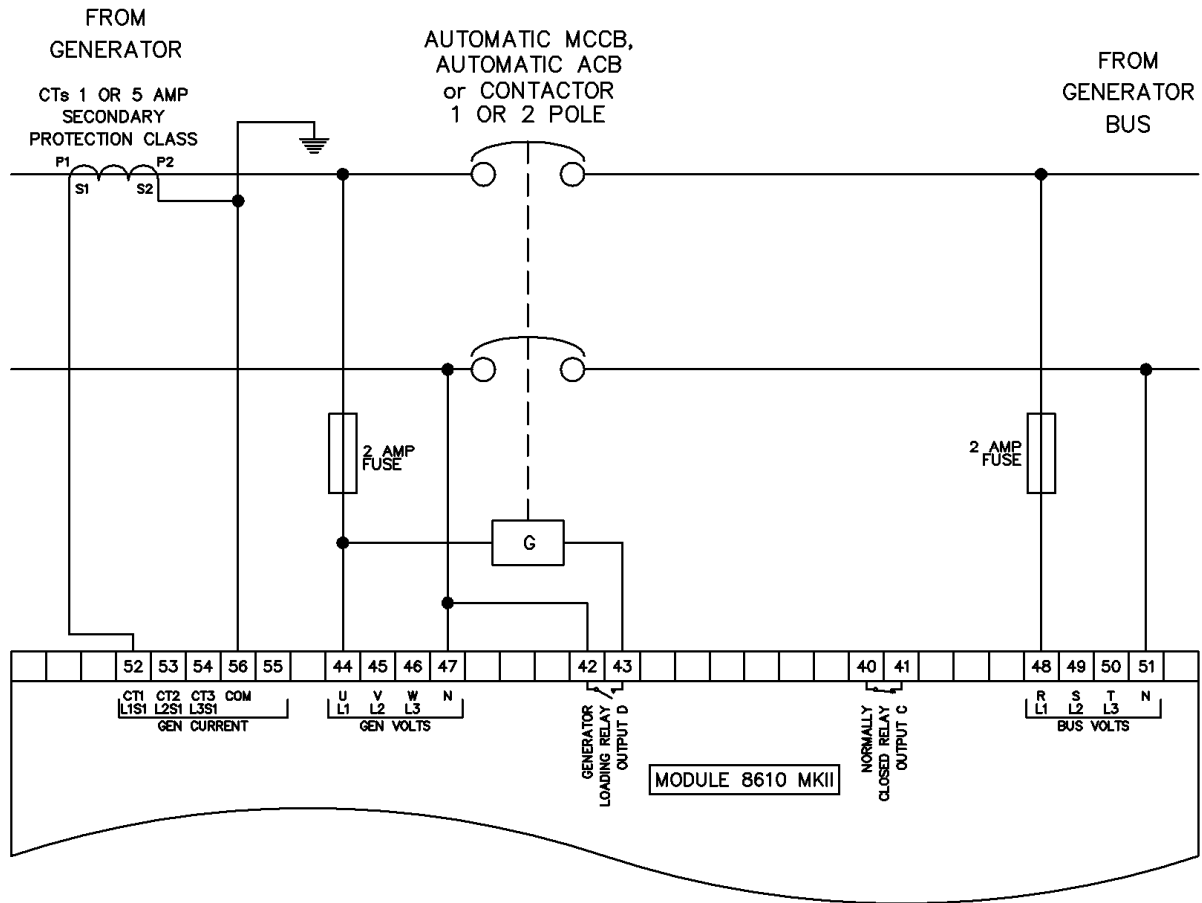

3.4.3 SINGLE PHASE (L1 & L2) 3 WIRE WITH RESTRICTED EARTH FAULT

NOTE: Earthing the neutral conductor 'before' the neutral CT allows the module to read earth faults 'after' the CT only (Restricted to load / downstream of the CT)
 Earthing the neutral conductor 'after' the neutral CT allows the module to read earth faults 'before' the CT only (Restricted to generator / upstream of the CT)

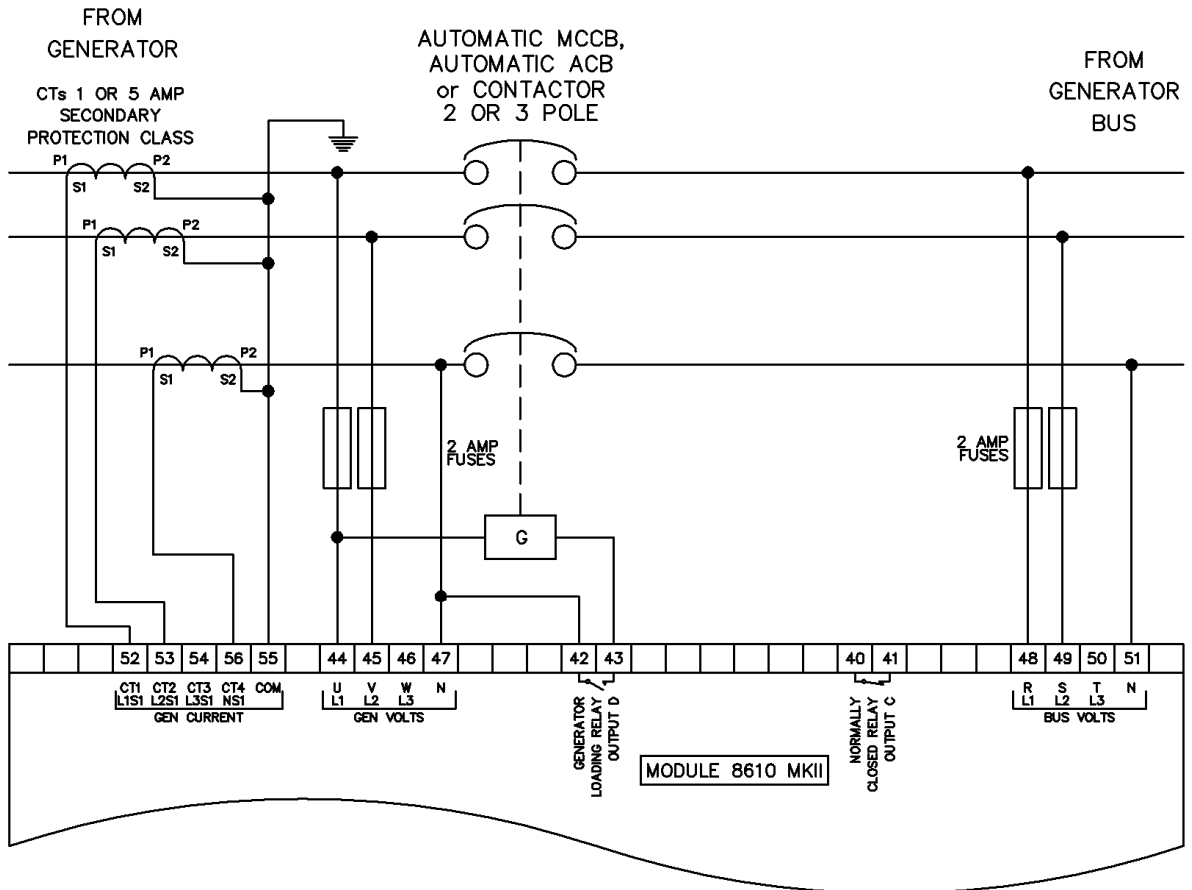

3.4.4 SINGLE PHASE (L1 & L2) 3 WIRE WITHOUT EARTH FAULT

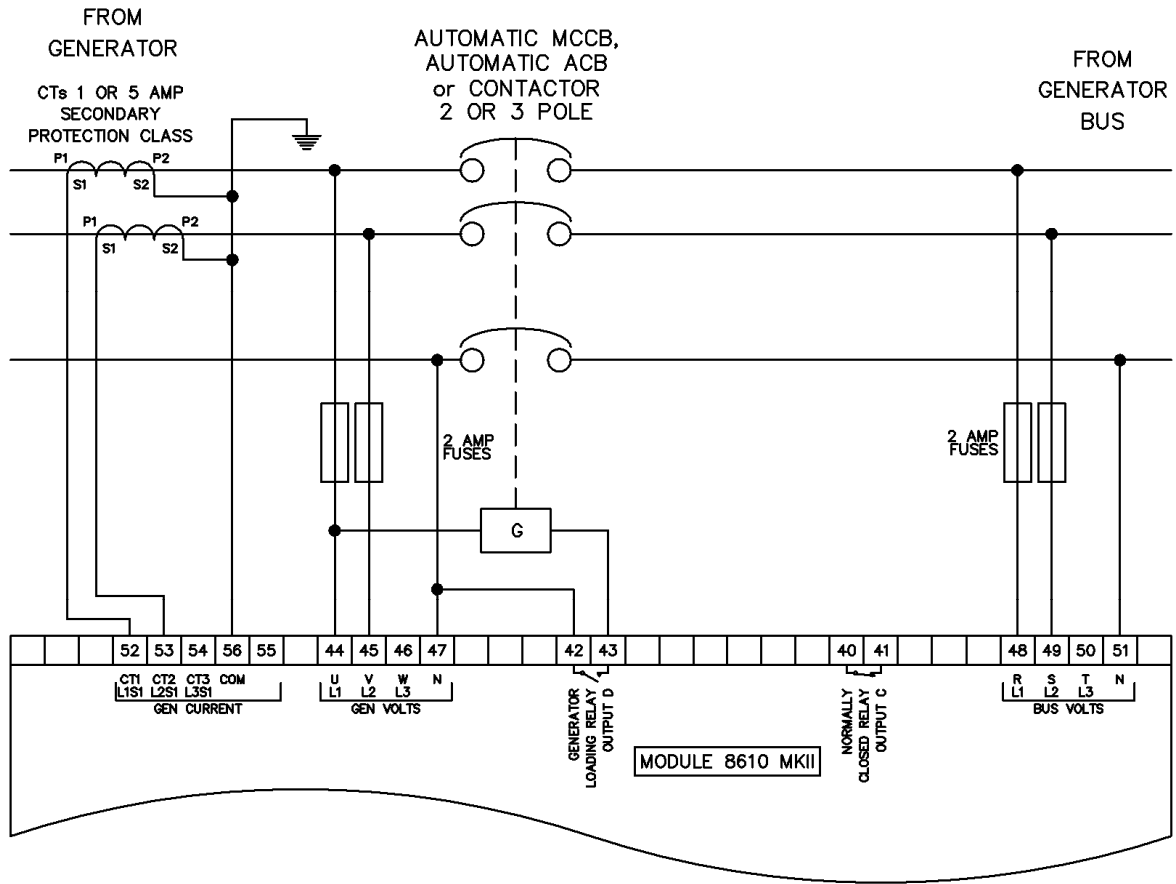

3.4.5 SINGLE PHASE (L1 & L3) 3 WIRE WITH RESTRICTED EARTH FAULT

NOTE: Earthing the neutral conductor 'before' the neutral CT allows the module to read earth faults 'after' the CT only (Restricted to load / downstream of the CT)
 Earthing the neutral conductor 'after' the neutral CT allows the module to read earth faults 'before' the CT only (Restricted to generator / upstream of the CT)

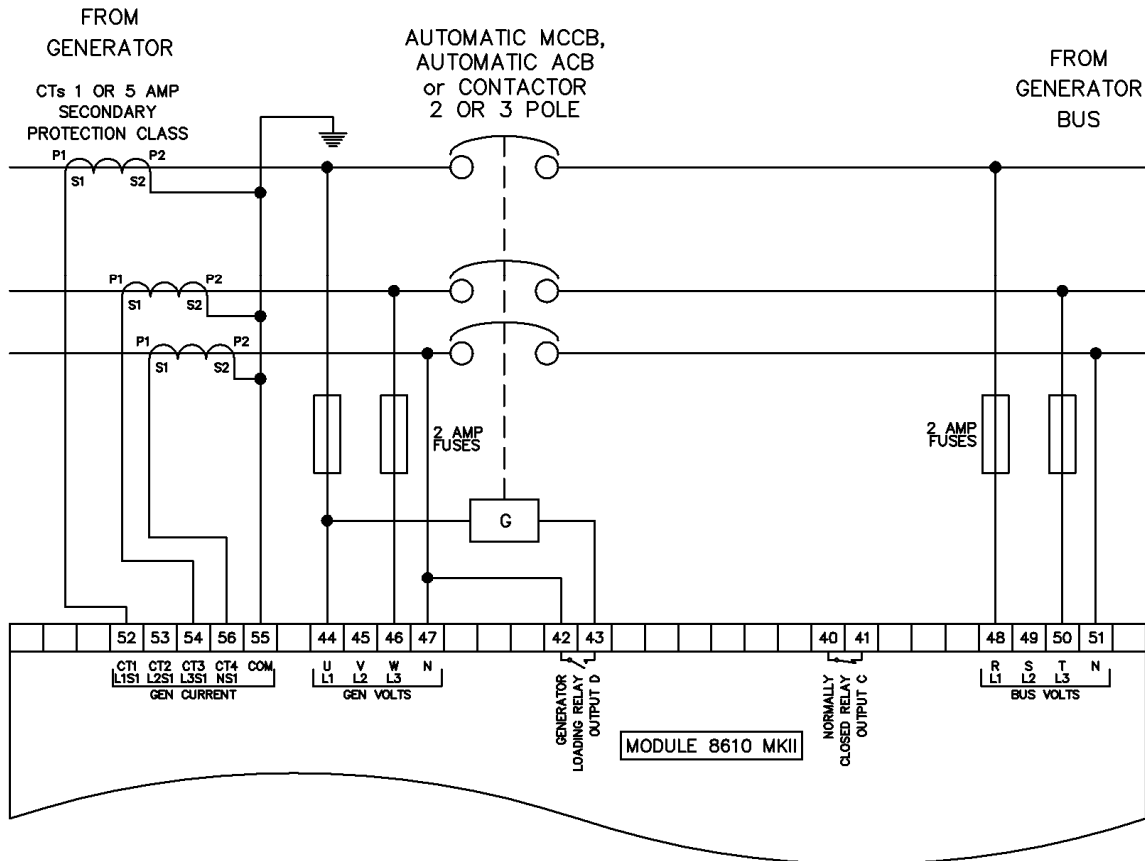

3.4.6 SINGLE PHASE (L1 & L3) 3 WIRE WITHOUT EARTH FAULT

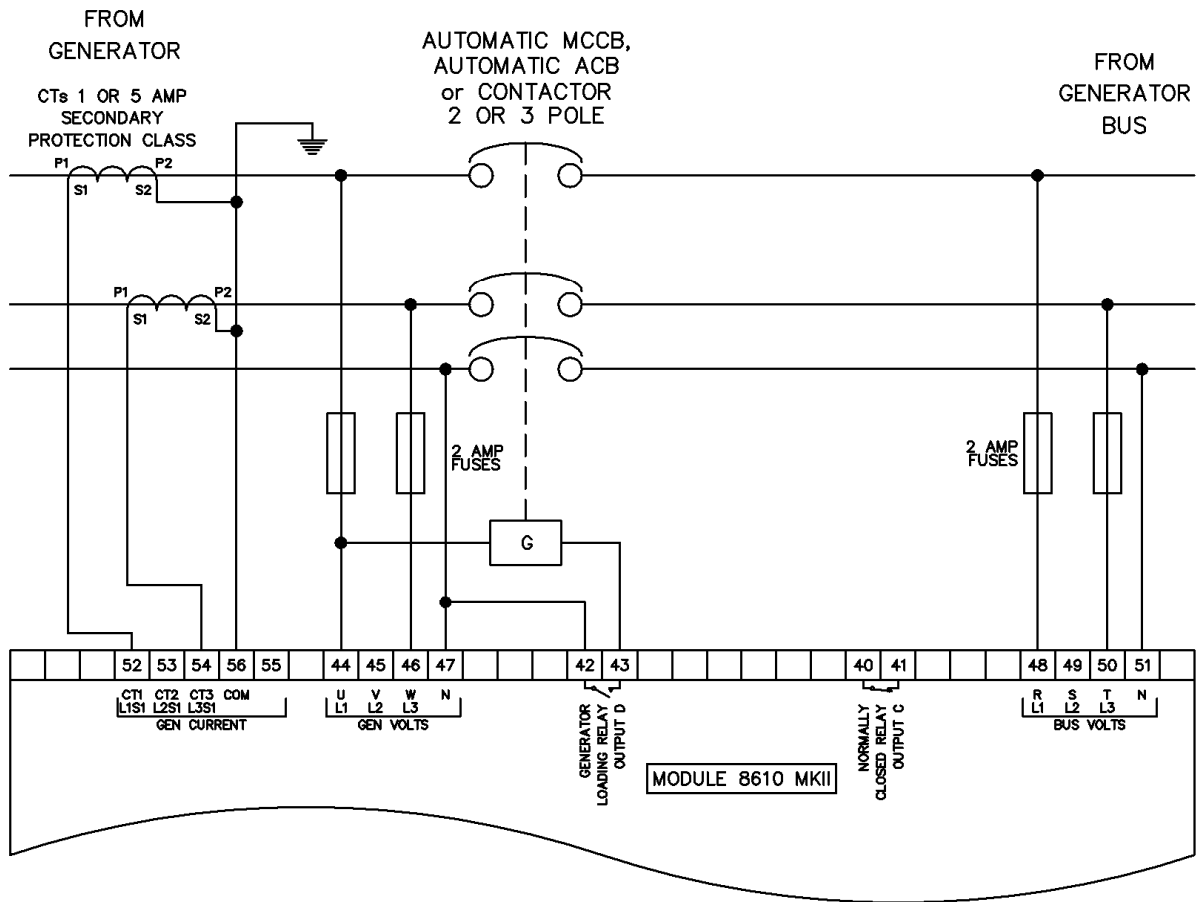

3.4.7 2 PHASE (L1 & L2) 3 WIRE WITH RESTRICTED EARTH FAULT

NOTE: Earthing the neutral conductor 'before' the neutral CT allows the module to read earth faults 'after' the CT only (Restricted to load / downstream of the CT)
 Earthing the neutral conductor 'after' the neutral CT allows the module to read earth faults 'before' the CT only (Restricted to generator / upstream of the CT)

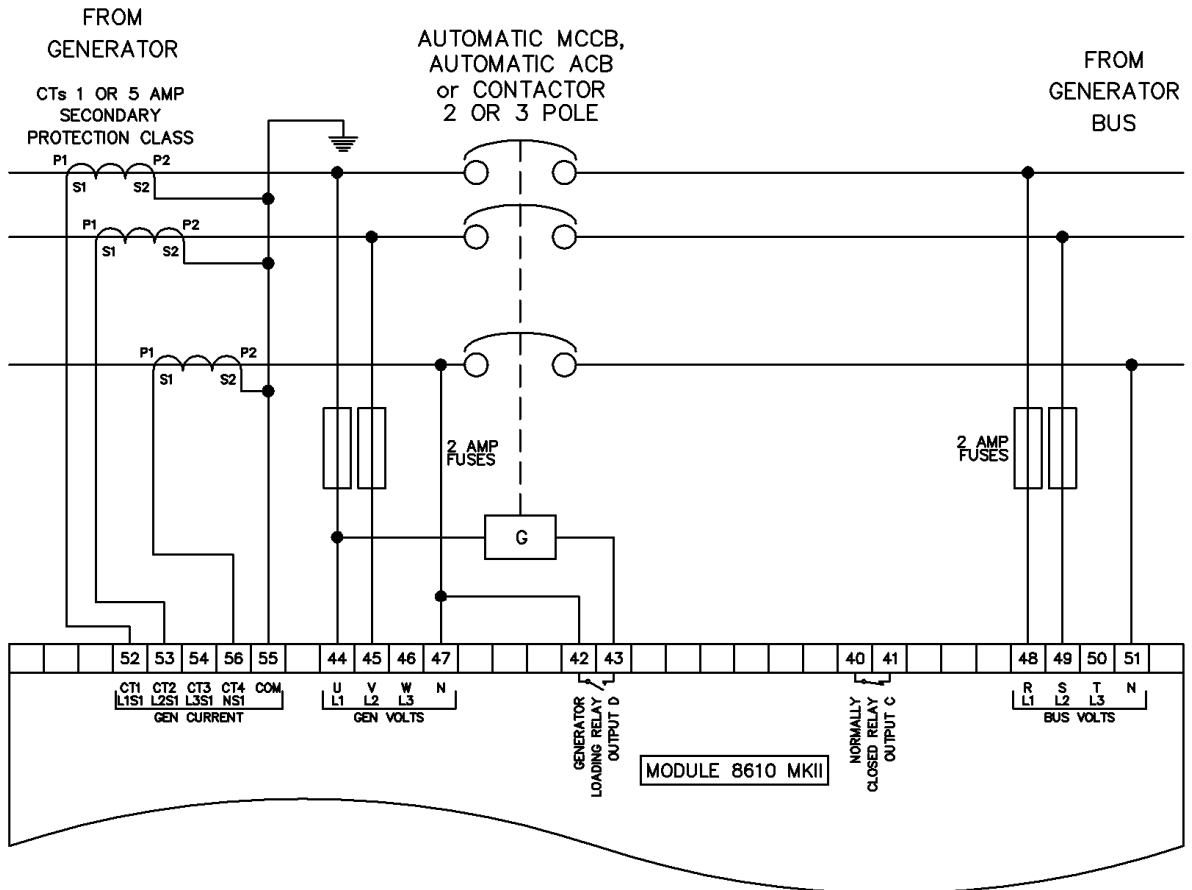

3.4.8 2 PHASE (L1 & L2) 3 WIRE WITHOUT EARTH FAULT

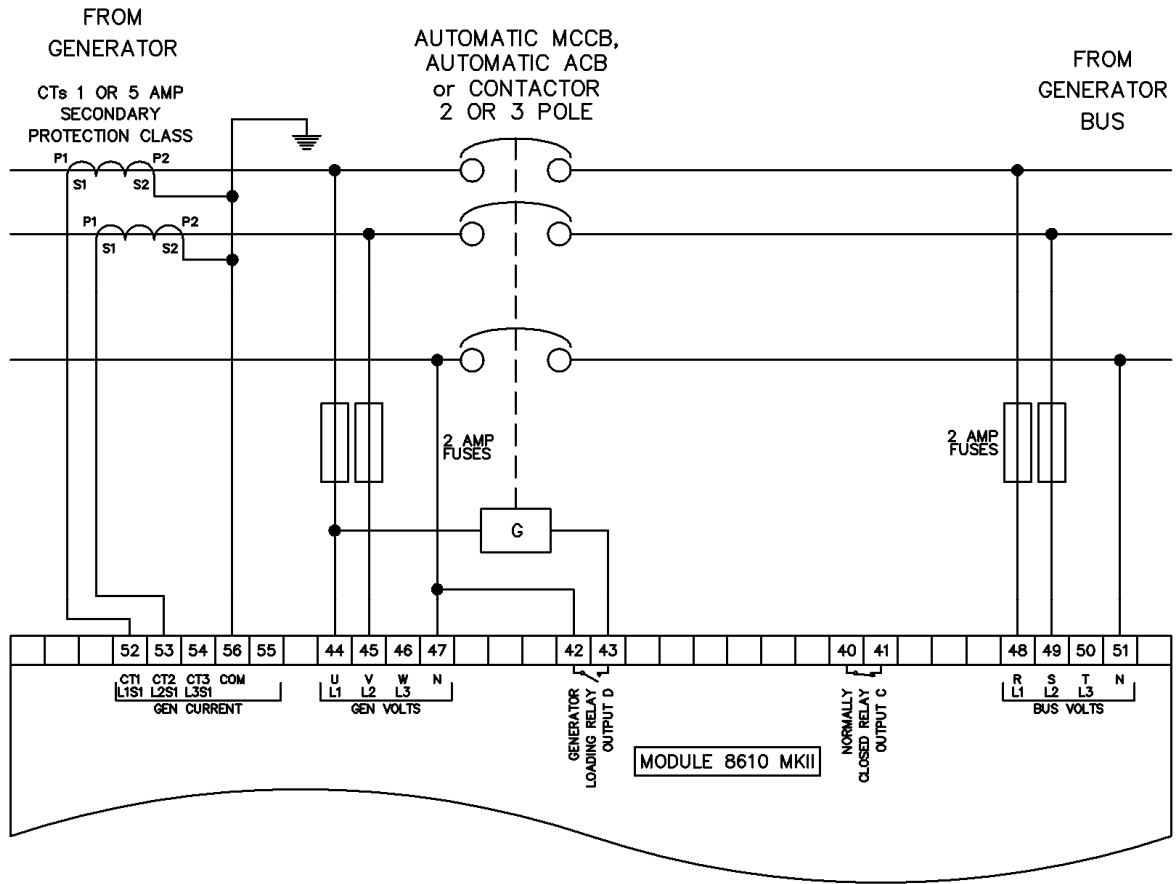

3.4.9 2 PHASE (L1 & L3) 3 WIRE WITH RESTRICTED EARTH FAULT

NOTE: Earthing the neutral conductor 'before' the neutral CT allows the module to read earth faults 'after' the CT only (Restricted to load / downstream of the CT)
 Earthing the neutral conductor 'after' the neutral CT allows the module to read earth faults 'before' the CT only (Restricted to generator / upstream of the CT)

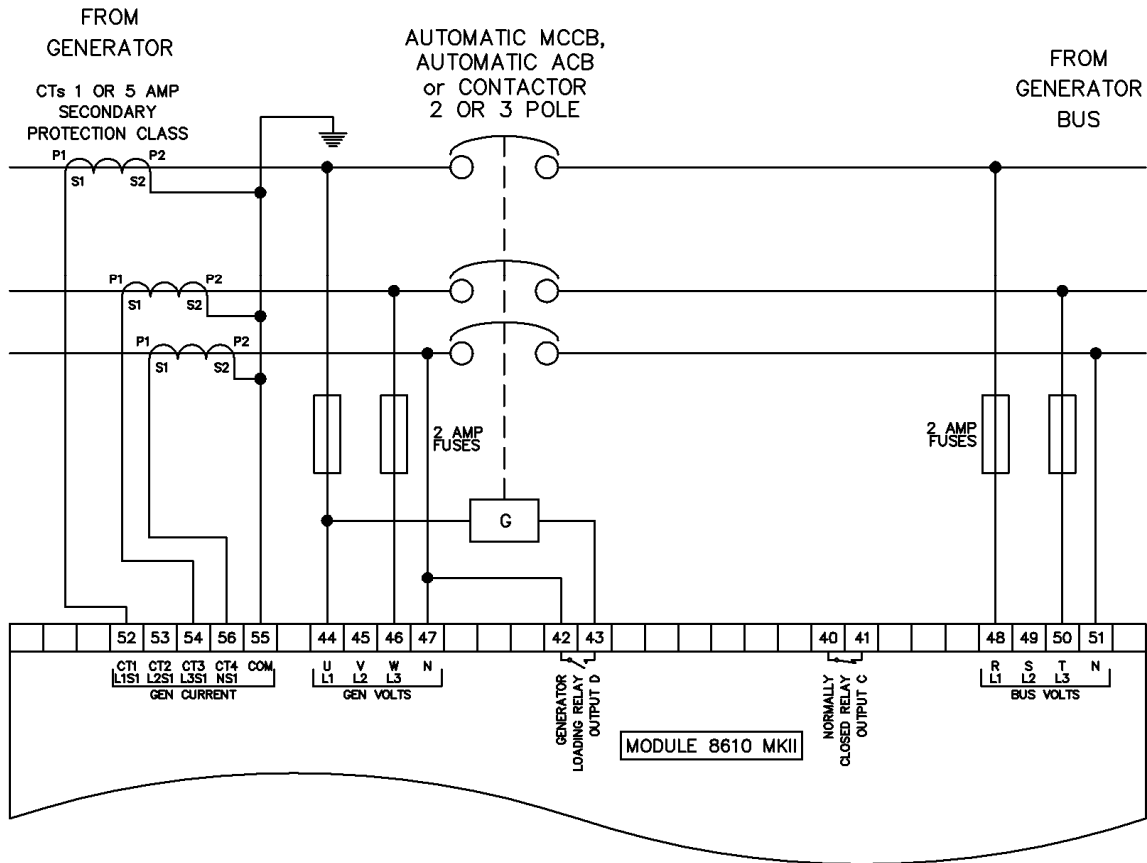

3.4.10 2 PHASE (L1 & L3) 3 WIRE WITHOUT EARTH FAULT

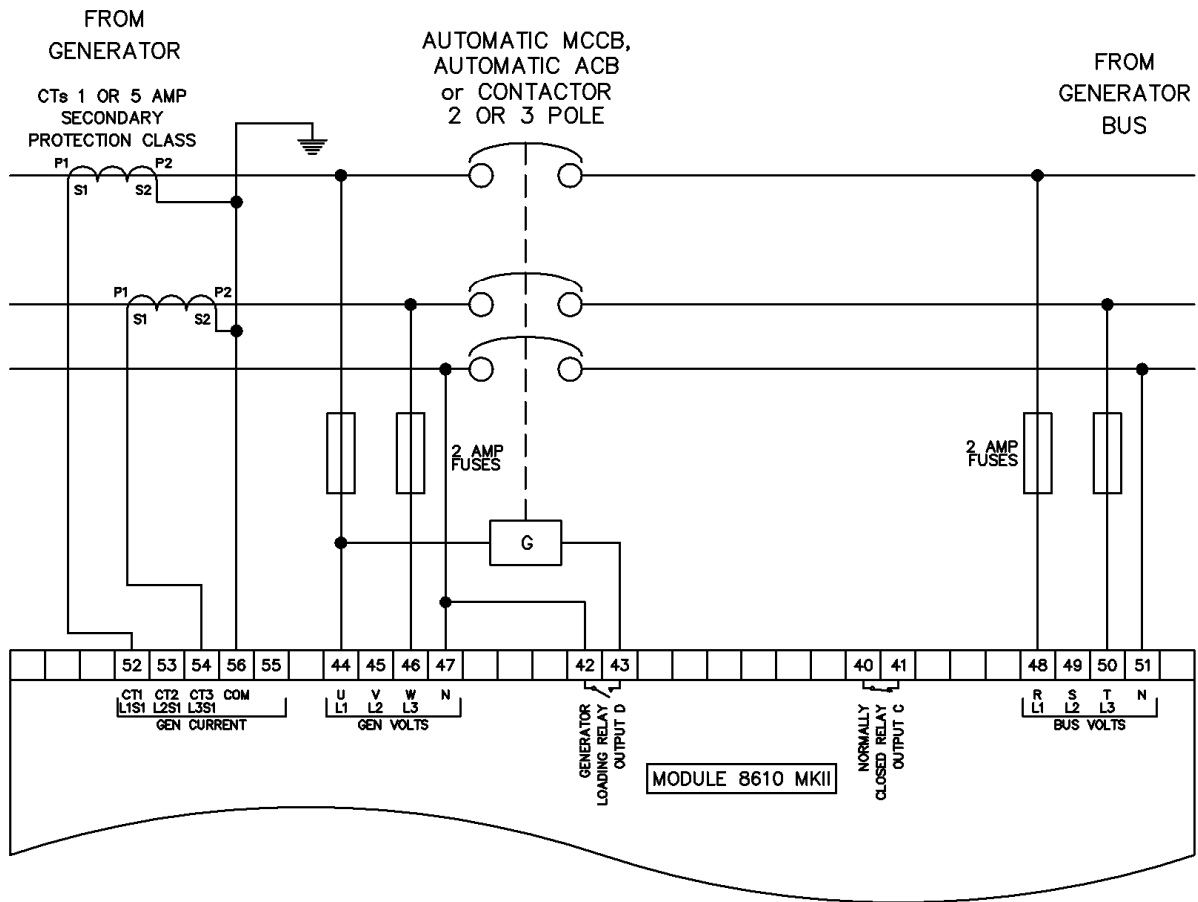

3.4.11 3 PHASE 3 WIRE DETLA WITHOUT EARTH FAULT

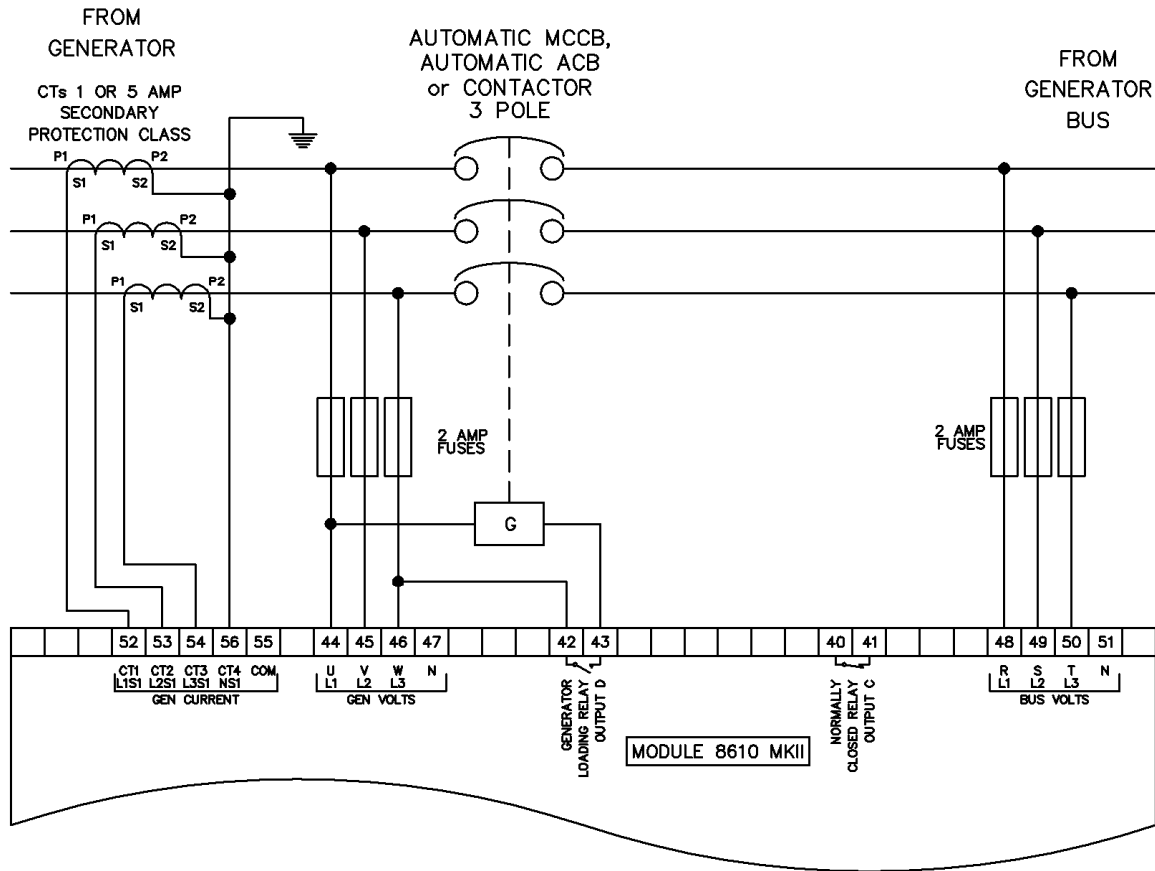

3.4.12 3 PHASE 4 WIRE WITHOUT EARTH FAULT

NOTE: The below diagram is applicable for the following AC topologies: 3 Phase 4 Wire Star, 3 Phase 4 Wire Delta L1-N-L2, 3 Phase 4 Wire Delta L2-N-L3 and 3 Phase 4 Wire Delta L2-N-L3. For further details of module configuration to suit these different topologies, refer to DSE Publication: 057-238 DSE8610 MKII Configuration Suite PC Software Manual.

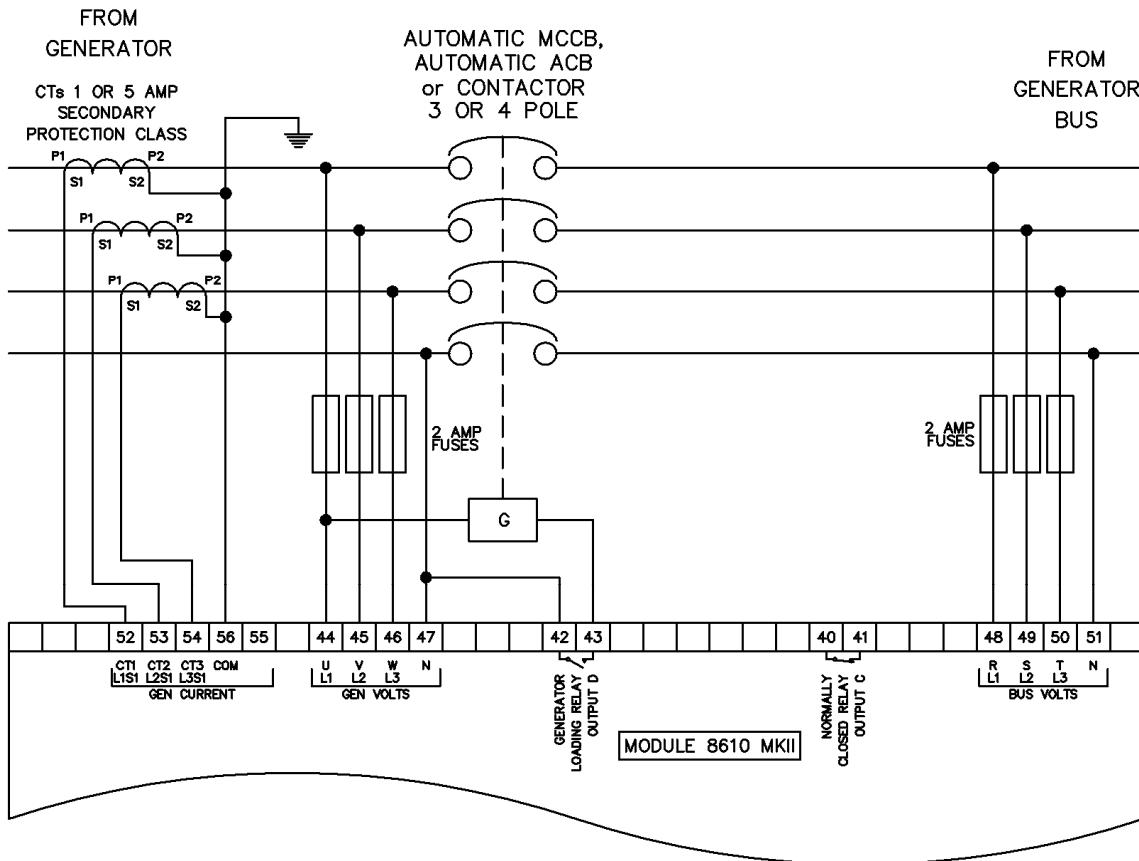

3.4.13 3 PHASE 4 WIRE WITH RESTRICTED EARTH FAULT

NOTE: The below diagram is applicable for the following AC topologies: 3 Phase 4 Wire Star, 3 Phase 4 Wire Delta L1-N-L2, 3 Phase 4 Wire Delta L1-N-L3 and 3 Phase 4 Wire Delta L2-N-L3. For further details of module configuration to suit these different topologies, refer to DSE Publication: 057-238 *DSE8610 MKII Configuration Suite PC Software Manual*.

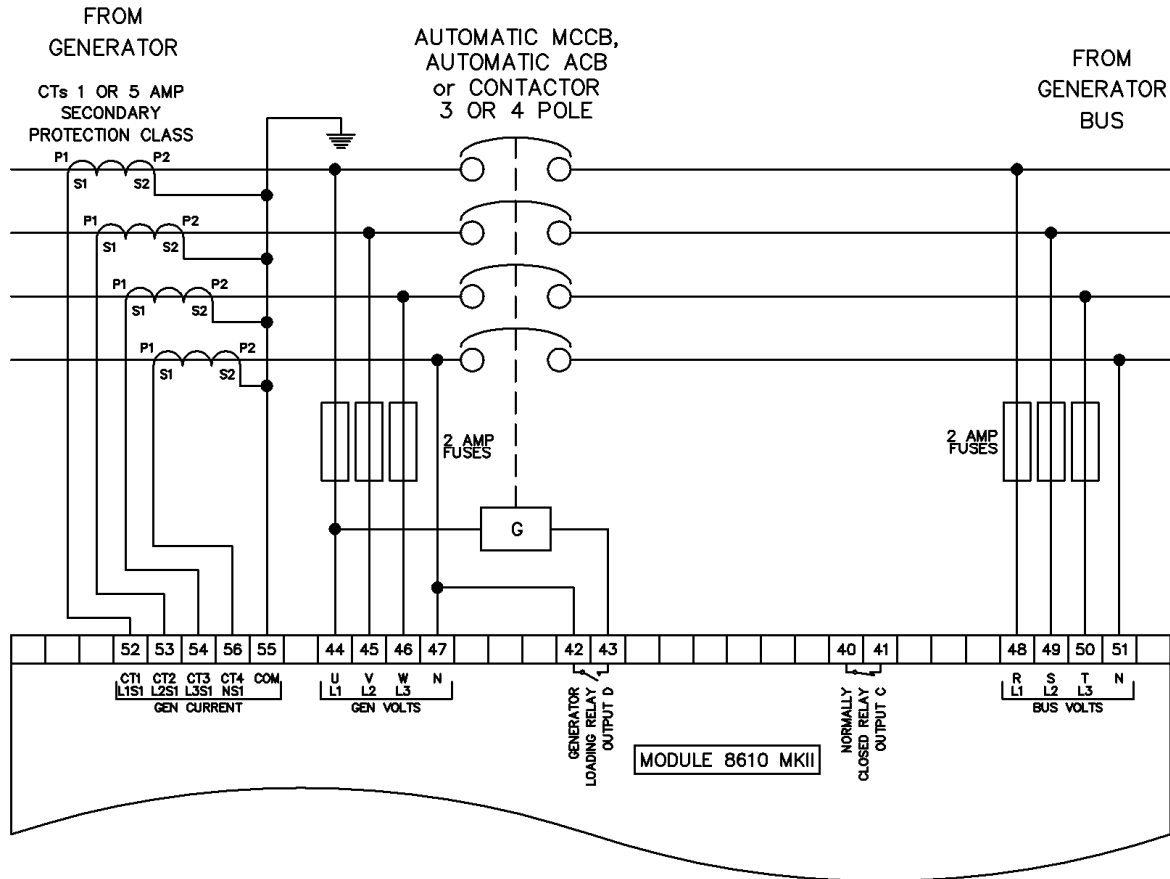

3.4.14 3 PHASE 4 WIRE WITH UNRESTRICTED EARTH FAULT

NOTE: The below diagram is applicable for the following AC topologies: 3 Phase 4 Wire Star, 3 Phase 4 Wire Delta L1-N-L2, 3 Phase 4 Wire Delta L2-N-L3 and 3 Phase 4 Wire Delta L2-N-L3. For further details of module configuration to suit these different topologies, refer to DSE Publication: 057-238 *DSE8610 MKII Configuration Suite PC Software Manual*.

This example shows the CTs in the neutral to earth link for a three phase four wire system to provide unrestricted earth fault protection but the same philosophy is applicable to the other topologies.

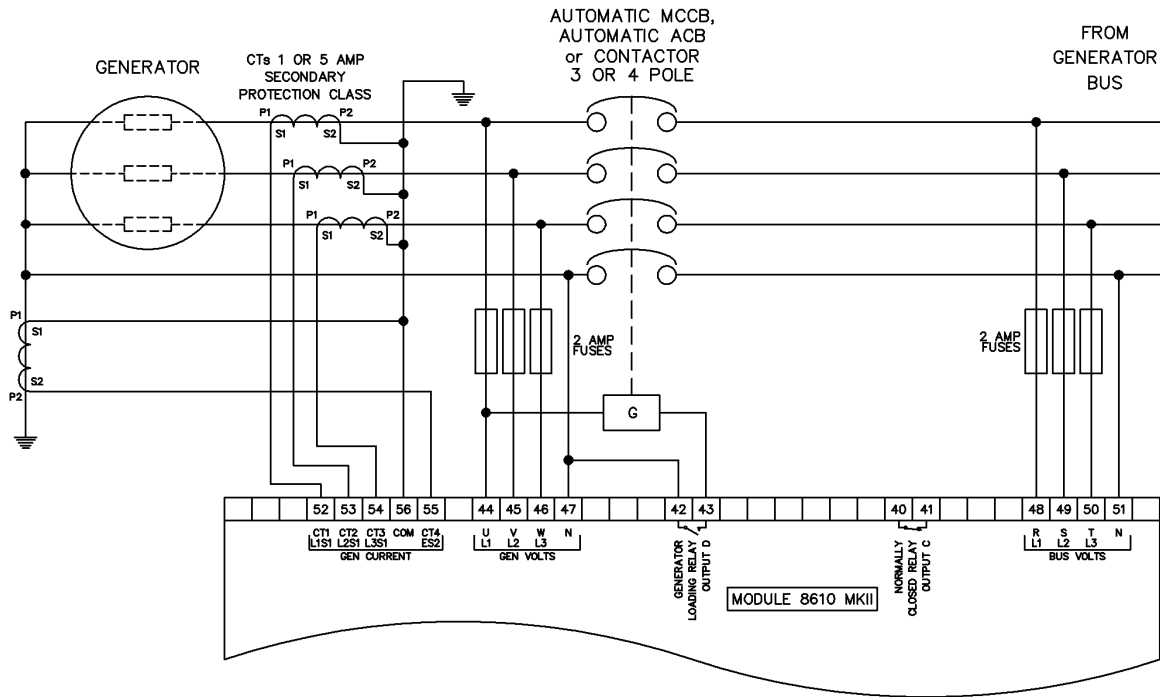

3.5 TYPICAL SINGLE LINE APPLICATION DRAWINGS

3.5.1 MULTI GENERATORS FOR PRIME POWER

NOTE: The below diagram is available in a larger scale. Contact DSE technical support for further information, support@deepseapl.com.

MSC LINK. 120 OHM SCREENED CABLE

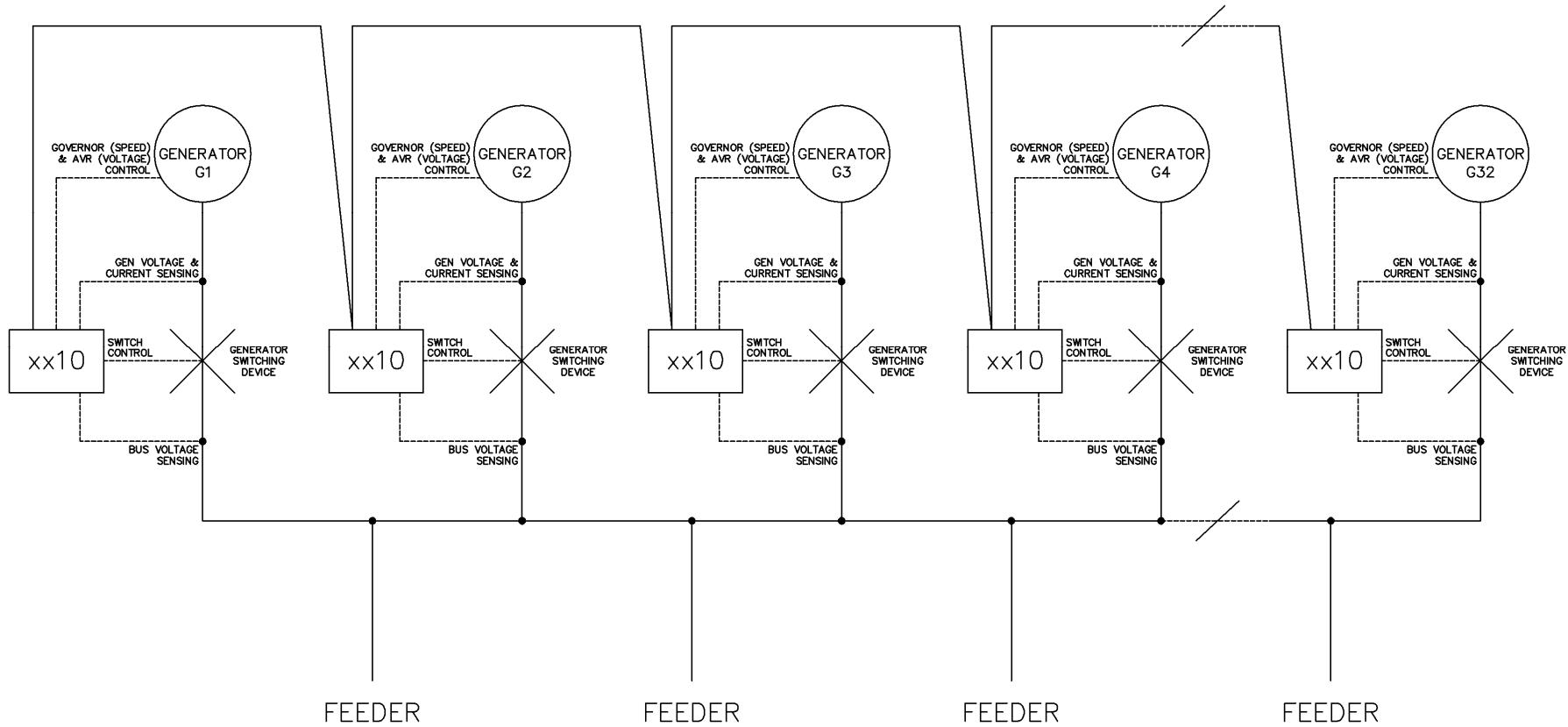

3.5.2 MULTI GENERATORS FOR PRIME POWER WITH BUS COUPLERS

NOTE: The below diagram is available in a larger scale. Contact DSE technical support for further information, support@deepseapl.com.

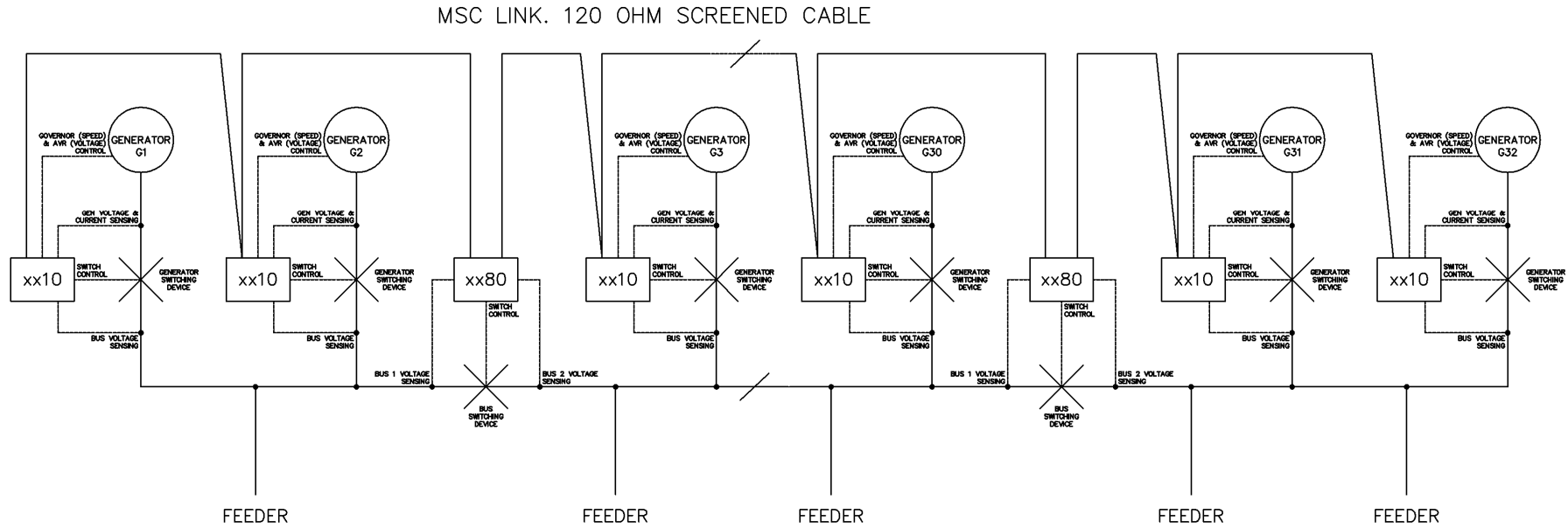

3.5.3 MULTI GENERATORS WITH SINGLE SYNCHRONISING TRANSFER SWITCH

NOTE: The below diagram is available in a larger scale. Contact DSE technical support for further information, support@deepseapl.com.

MSC LINK. 120 OHM SCREENED CABLE

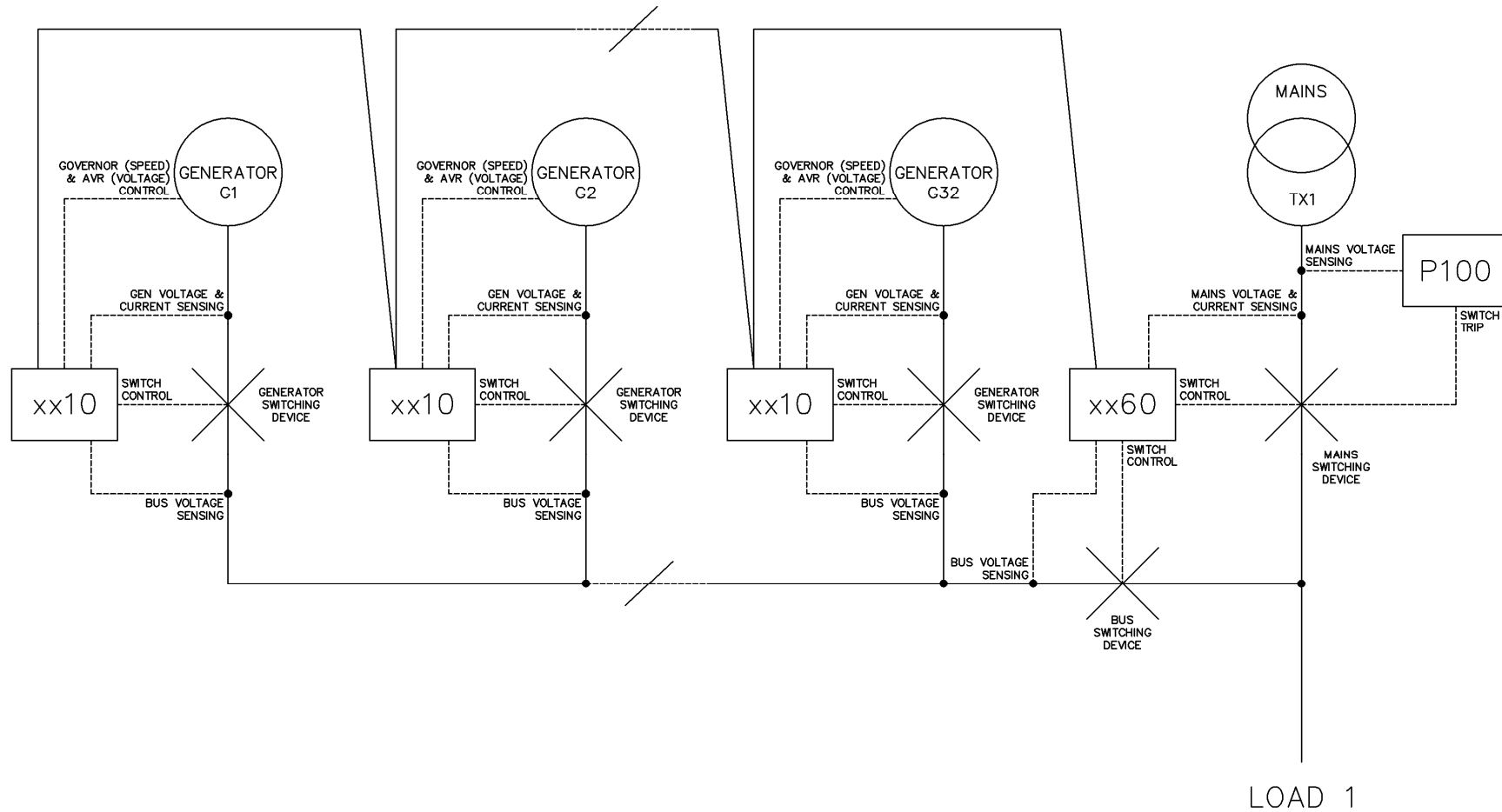

3.5.4 MULTI GENERATORS WITH TWO SYNCHRONISING TRANSFER SWITCHES

NOTE: The below diagram is available in a larger scale. Contact DSE technical support for further information, support@deepseapl.com.

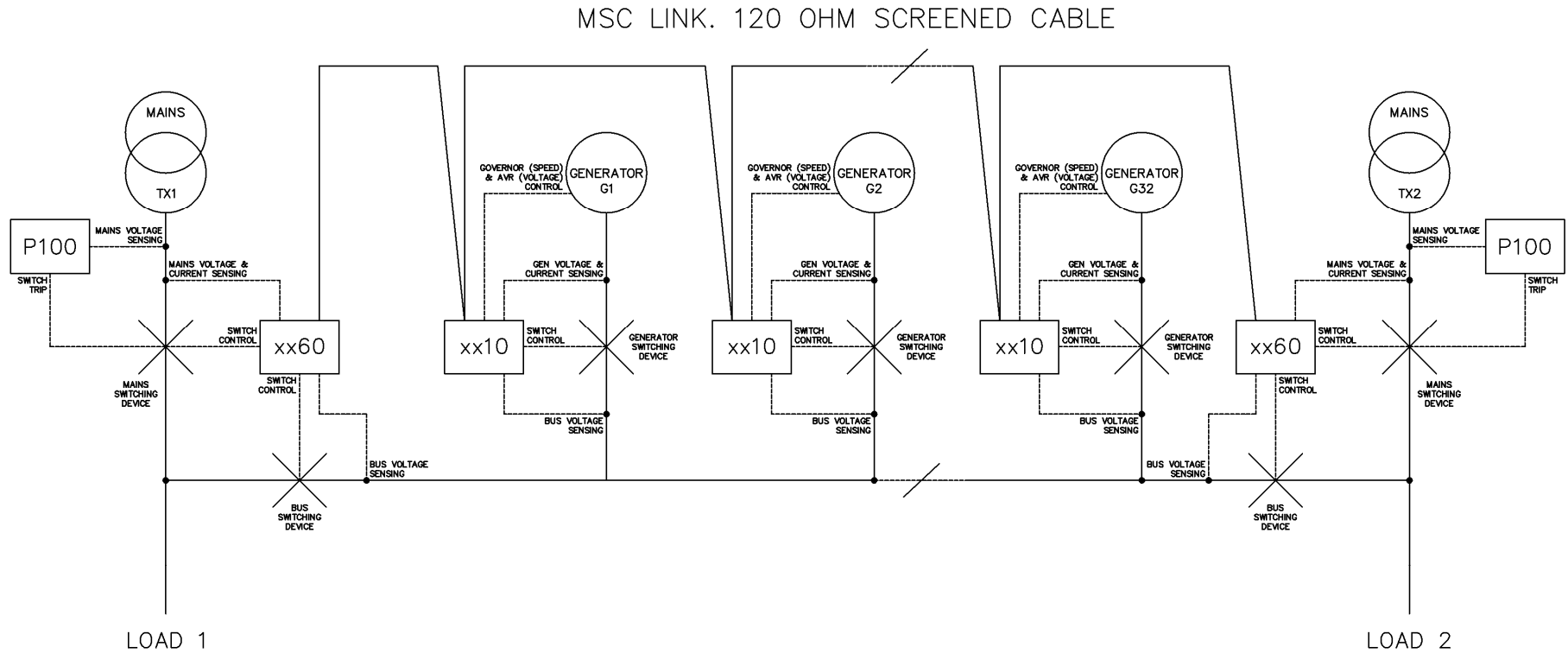

3.5.5 MULTI GENERATORS & SYNCHRONISING TRANSFER SWITCHES

NOTE: The below diagram is available in a larger scale. Contact DSE technical support for further information, support@deepseapl.com.

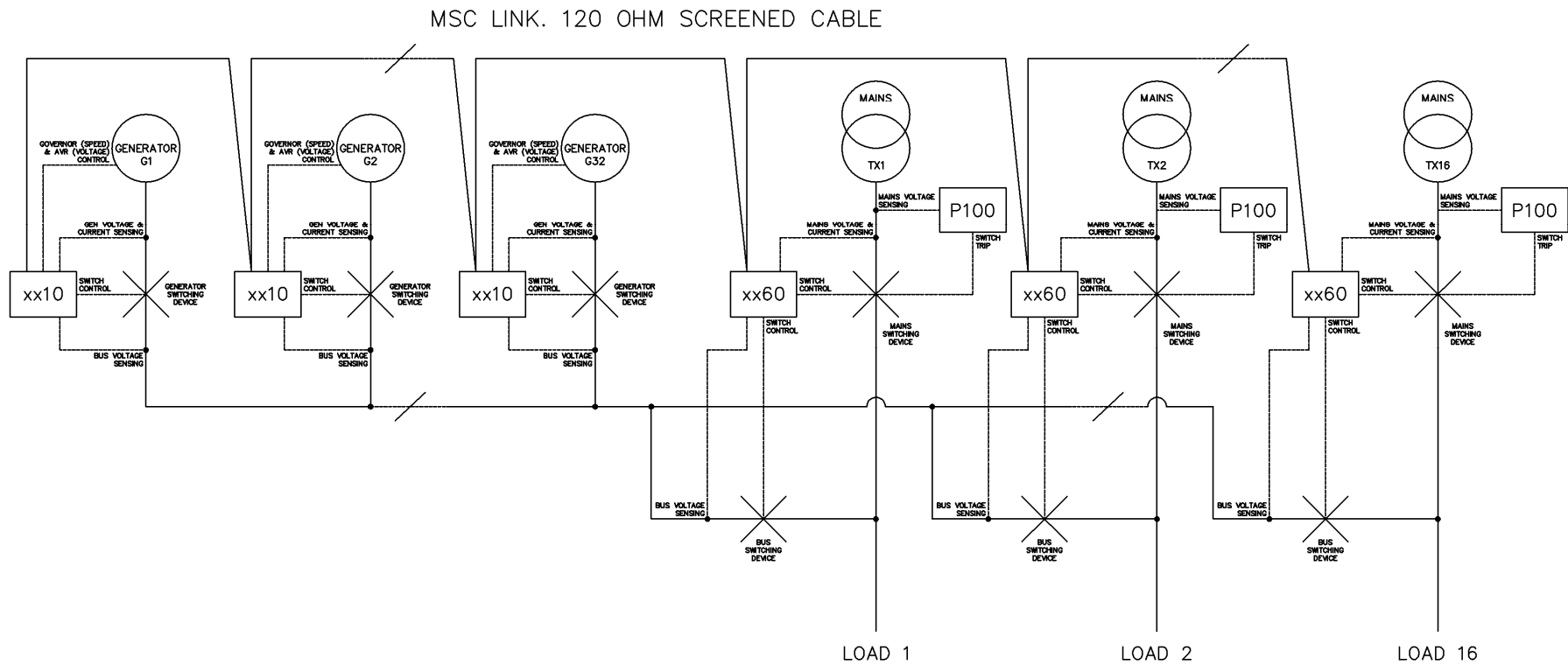

3.5.6 MULTI GENERATORS & TRANSFER SWITCHES WITH BUS COUPLER

NOTE: The below diagram is available in a larger scale. Contact DSE technical support for further information, support@deepseapl.com.

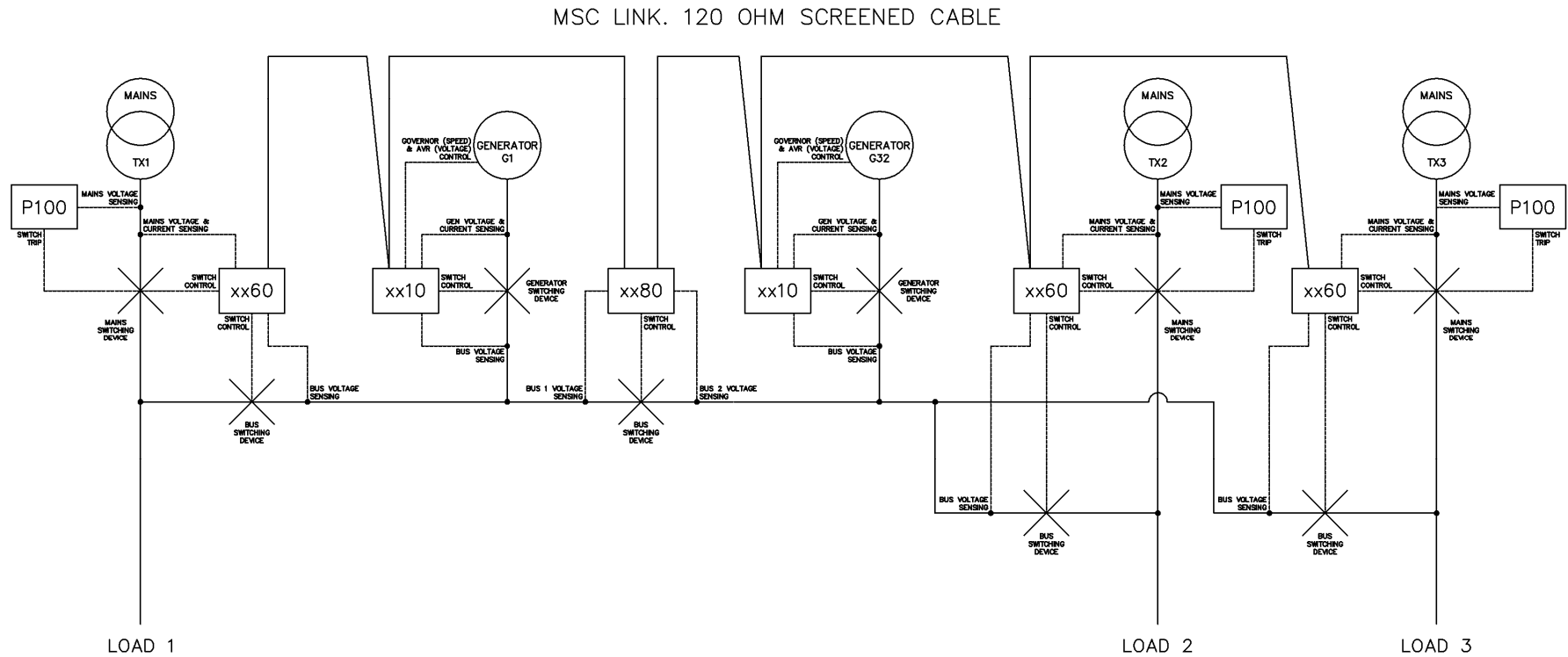

3.5.7 SINGLE GENERATOR EXPORTING (BASE LOADING) POWER

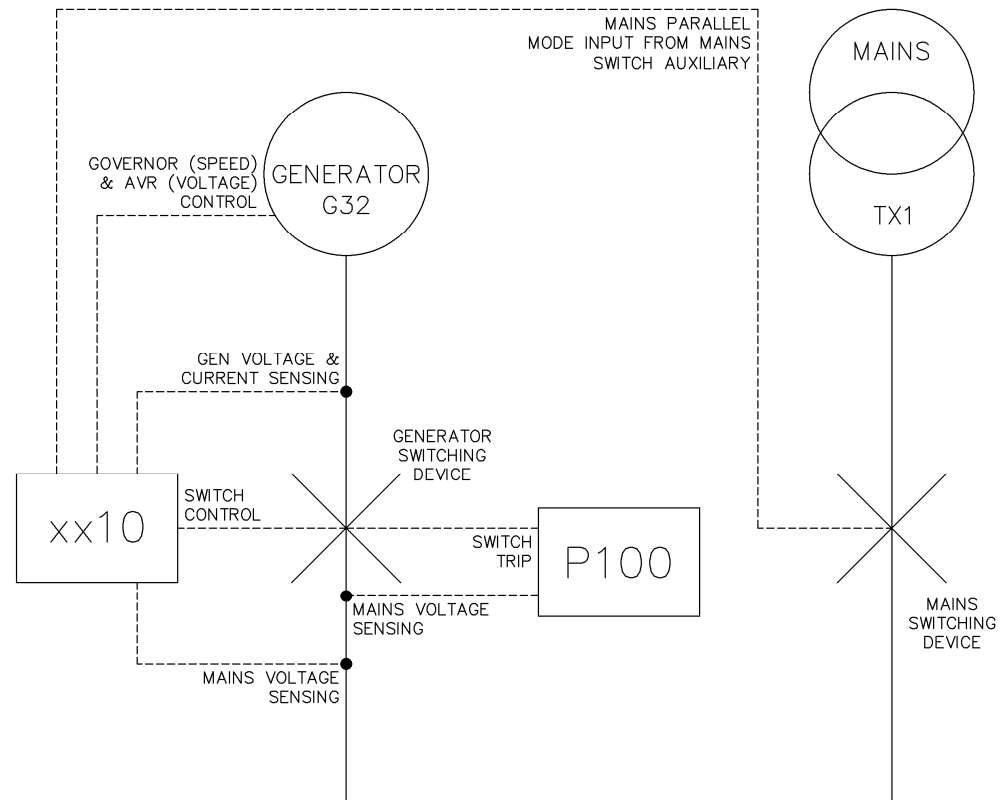

4 DESCRIPTION OF CONTROLS









CAUTION: The module may instruct an engine start event due to external influences. Therefore, it is possible for the engine to start at any time without warning. Prior to performing any maintenance on the system, it is recommended that steps are taken to remove the battery and isolate supplies.



NOTE: The following descriptions detail the sequences followed by a module containing the standard 'factory configuration'. Always refer to your configuration source for the exact sequences and timers observed by any particular module in the field.

Control of the module is via push buttons mounted on the front of the module with





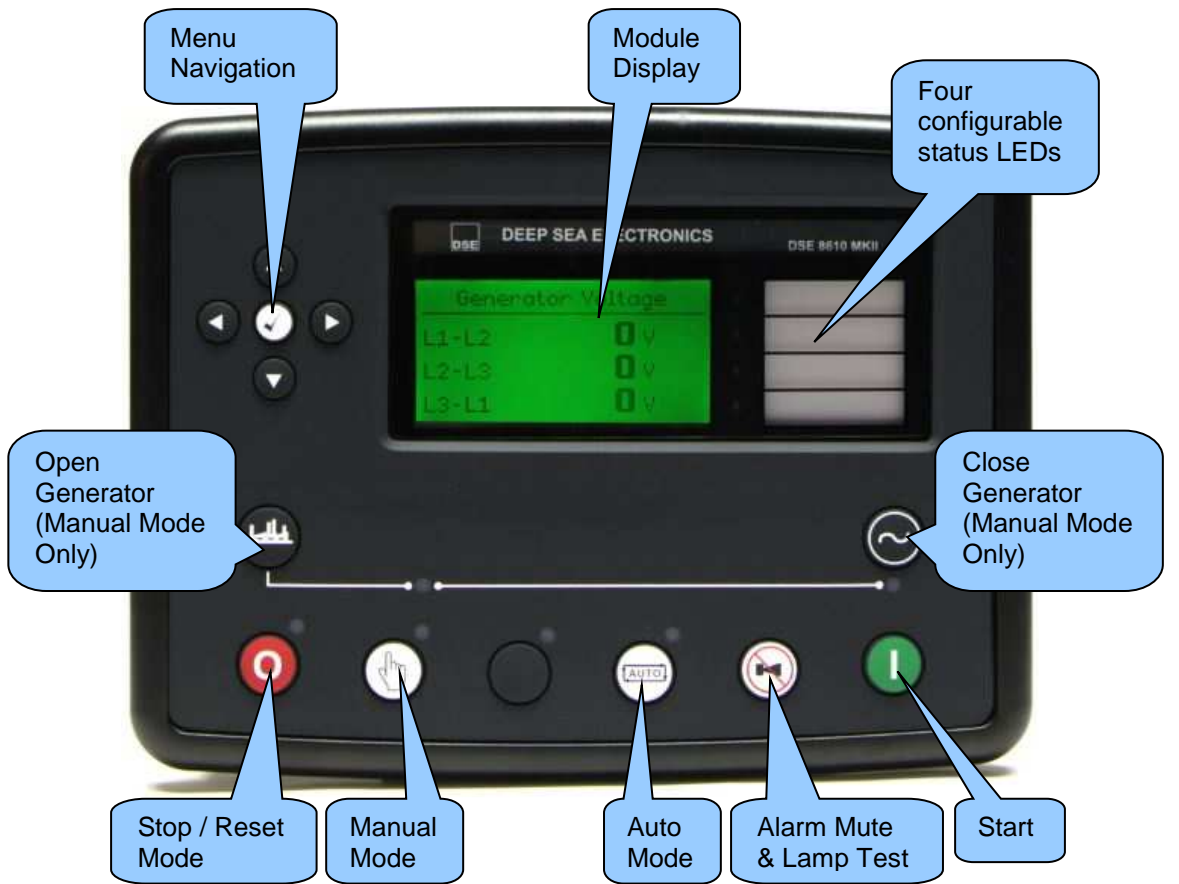









Stop/Reset Mode , **Manual Mode** , **Auto Mode** , **Start**  **Close Generator**  and **Open Generator**  functions. For normal operation, these are the only controls which need to be operated. Details of their operation are provided later in this document.

Description of Controls























4.1 CONTROL PUSH BUTTONS

 **NOTE:** For further details, see section entitled *Operation* elsewhere in this manual.

Icon	Description
	<p>Stop / Reset Mode</p> <p>This button places the module into its Stop/Reset Mode . This clears any alarm conditions for which the triggering criteria has been removed. If the engine is running and the module is put into Stop/Reset Mode , the module automatically instructs the generator off load ('Close Generator Output' becomes inactive)</p> <p>Stop/Reset Mode  the generator remains at rest</p>
	<p>Manual Mode</p> <p>This button places the module into its Manual Mode . Once in Manual Mode , the module responds to the Start  button to start the generator and run it off load.</p> <p>To place the generator on load, use the Transfer to Generator  button. The module automatically instructs the generator to synchronise and once in sync, to be place the generator on load ('Close Generator Output' becomes active).</p> <p>To place the generator off load, use the Open Generator  button. The module automatically ramps the load off the generator and then takes it off load ('Close Generator Output' becomes inactive). Additional digital inputs are available to perform these functions.</p> <p>If the generator is running off-load in Manual Mode  and on load signal becomes active, the module automatically instructs the generator to synchronise and once in sync, to be place the generator on load ('Close Generator Output' becomes active).</p> <p>Upon removal of the on load signal, the generator remains on load until either selection of the Stop/Reset Mode  or Auto Mode .</p>
	<p>Auto Mode</p> <p>This button places the module into its Auto Mode . This mode allows the module to control the function of the generator automatically. The module monitors numerous start requests via inputs on the MSC link and when one has been made, the set is automatically started. Once the generator is available, the module automatically instructs the generator to synchronise and once in sync, to be place the generator on load ('Close Generator Output' becomes active).</p> <p>Upon removal of the starting signal, the module starts the <i>Return Delay Timer</i> and once expired, the load is automatically ramped off the generator and then it is taken off load ('Close Generator Output' becomes inactive). The generator then continues to run for the duration of the <i>Cooling Timer</i> until it stops. The module then waits for the next start event.</p>

 **NOTE:** For further details, see section entitled *Operation* elsewhere in this manual.

Icon	Description
	<p>Alarm Mute / Lamp Test</p> <p>This button silences the audible alarm in the controller, de-activates the <i>Audible Alarm</i> output (if configured) and illuminates all of the LEDs on the module's fascia as a lamp test function.</p>
	<p>Start</p> <p>This button is only active in the Stop/Reset Mode , Manual Mode </p> <p>Pressing the Start  button in Stop/Reset Mode  powers up the engine's ECU but does not start the engine. This can be used to check the status of the CAN communication and to prime the fuel system.</p> <p>Pressing the Start  button in Manual Mode  starts the generator and runs it off load in Manual Mode </p>
	<p>Menu Navigation</p> <p>Used for navigating the instrumentation, event log and configuration screens.</p>
	<p>Close Generator</p> <p>The Close Generator  button controls the operation of the generator load switch and is only active in the Manual Mode  once the generator is available.</p> <p>Pressing the Close Generator  button when the generator is available and off load automatically instructs the generator to synchronise and once in sync, to be place the generator on load ('Close Generator Output' becomes active). If the generator bus is dead (has not supply on it) the generator is placed on load immediately. Further presses of the Close Generator  button have no effect.</p>
	<p>Open Generator</p> <p>The Open Generator  button is only active in the Manual Mode  and allows the operator to open the generator load switch.</p> <p>Pressing the Open Generator  button when the Generator is on load, automatically ramps the load off the generator and then takes it off load ('Close Generator Output' becomes inactive). Further presses of the Open Generator  button have no effect.</p>

4.2 VIEWING THE INSTRUMENT PAGES





NOTE: Depending upon the module's configuration, some display screens may be disabled. For further details of module configuration, refer to DSE Publication: *057-238 DSE8610 MKII Configuration Suite PC Software Manual*.

It is possible to scroll to display the different pages of information by repeatedly operating the

Next & Previous Page  buttons.

Example

If you want to view one of the instrument pages towards the end of the list, it may be quicker to scroll left through the pages rather than right!

Status  **Generator**  **Engine**  **Next Page Button**  returns the Status page.

And so on until the desired page is reached. Further presses of the

The complete order and contents of each information page are given in the following sections

Once selected, the page remains on the LCD display until the user selects a different page, or after an extended period of inactivity (*LCD Page Timer*), the module reverts to the status display.

If no buttons are pressed upon entering an instrumentation page, the instruments displayed are automatically subject to the setting of the *LCD Scroll Timer*.

The *LCD Page* and *LCD Scroll* timers are configurable using the DSE Configuration Suite Software or by using the Front Panel Editor.

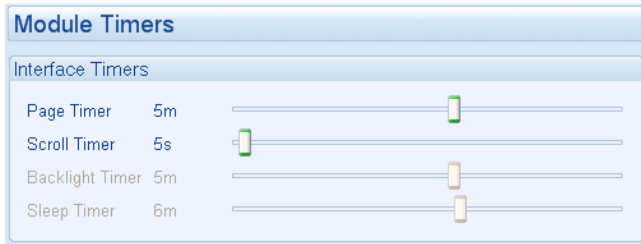

The screenshot shows the factory settings for the timers, taken from the DSE Configuration Suite PC Software.

Alternatively, to scroll manually through all instruments on the currently selected page, press the



Instrumentation Scroll  buttons. The 'auto scroll' is disabled.

To re-enable 'auto scroll' press the **Instrumentation Scroll**  buttons to scroll to the 'title' of the instrumentation page (ie Engine). A short time later (the duration of the *LCD Scroll Timer*), the instrumentation display begins to auto scroll.

When scrolling manually, the display automatically returns to the Status page if no buttons are pressed for the duration of the configurable *LCD Page Timer*.

If an alarm becomes active while viewing the status page, the display shows the Alarms page to draw the operator's attention to the alarm condition.

4.2.1 STATUS

 **NOTE:** Press the *Instrumentation Scroll*  buttons on the *Status Page* to view other Configurable Status Screens if configured. For further details of module configuration, refer to DSE Publication: 057-238 *DSE8610 MKII Configuration Suite PC Software Manual*.

This is the 'home' page, the page that is displayed when no other page has been selected, and the page that is automatically displayed after a period of inactivity (*LCD Page Timer*) of the module control buttons.

This page changes with the action of the controller for example when the generator is running and available:

Status	22:31	Factory setting of <i>Status</i> screen showing engine stopped...
Generator at Rest		
Stop Mode		

Status	22:31	...and engine running
Generator Available		

4.2.1.1 GENERATOR LOCKED OUT

Status	22:31	<i>Generator Locked Out</i> indicates that the Generator cannot be started due to an active <i>Shutdown</i> or <i>Electrical Trip Alarm</i> on the
Generator Locked Out		

module. Press the **Next or Previous Page**  button to scroll

to the alarms page to investigate. Press the **Stop/Reset Mode**  button to clear the alarm, if the alarm does not clear the fault is still active.

4.2.1.2 WAITING FOR GENERATOR

 **NOTE:** For further details of module configuration, refer to DSE Publication: 057-238 *DSE8610 MKII Configuration Suite PC Software Manual*.

Status	22:31	<i>Waiting For Generator</i> indicates that the Generator has started but has not reached the required <i>Loading Voltage</i> and or <i>Loading Frequency</i> as set in the module's configuration. Press the
Waiting For Generator		

Next or Previous Page  buttons to scroll to the *Generator* page to check to see if the generator voltage and frequency is higher then the configured *Loading Voltage* and *Loading Frequency*.

4.2.1.3 CONFIGURABLE STATUS SCREENS

The contents of the Home Page may vary depending upon configuration by the generator manufacturer or supplier. Below is an example of the Home Page being changed to show engine CAN related information.

The screenshot shows a configuration interface titled "Configurable Status Screens". Under the "Home Page" section, a dropdown menu is set to "Instrumentatio". Below this is a "Displayed Pages" section with a grid of 10 pages. Page 1 is set to "EPA Icons", while pages 2 through 10 are set to "Not Used".

Page	Page 1	Page 2	Page 3	Page 4	Page 5	Page 6	Page 7	Page 8	Page 9	Page 10
Page 1	EPA Icons	Not Used	Not Used	Not Used	Not Used	Not Used	Not Used	Not Used	Not Used	Not Used

Callout 1: The configured status pages are displayed as the Home Page

Callout 2: Example of EPA icons being selected to be the default Home Page.

Callout 3: Other pages can be configured to be shown, automatically scrolling when the set is running.

EPA Home Screen Example:



For further information about the icons, refer to *Engine* section elsewhere in this manual.

4.2.2 ENGINE

 **NOTE***: For further details of support engine, refer to DSE Publication: *057-004 Electronic Engines and DSE Wiring Guide*.

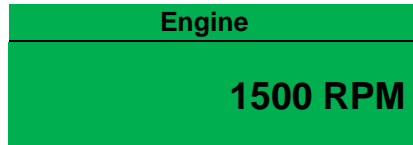

These pages contain instrumentation gathered about the engine measured or derived from the module's inputs, some of which may be obtained from the engine ECU.



Engine Speed
Oil Pressure
Coolant Temperature
Engine Battery Volts
Engine Run Time
Engine Fuel Level
Oil Temperature*
Coolant Pressure*
Inlet Temperature*
Exhaust Temperature*
Fuel Temperature*
Turbo Pressure*
Fuel Pressure*
Fuel Consumption*
Fuel Used*
Flexible Sensors
Engine Maintenance Alarm 1
Engine Maintenance Alarm 2
Engine Maintenance Alarm 3
After Treatment Fuel Used*
After Treatment Exhaust Gas Temperature*
Engine Oil Level*
Engine Crank Case Pressure*
Engine Coolant Level*
Engine Injector Rail Pressure*
Engine Exhaust Temperature*
Intercooler Temperature*
Turbo Oil Pressure*
Fan Speed*
Water In Fuel*
Air Inlet Pressure*
ECU Regeneration*
ECU Regeneration Icons*
Engine Soot Levels*
DEF Tank Level*
DEF Tank Temperature*
DEF Reagent Cons*
SCR After Treatment Status*
ECU ECR DEF Icons*
DEF Counter Minimum*
DPTC Filter Status*
Engine ECU Link*
Tier 4 Engine Information*

4.2.2.1 MANUAL FUEL PUMP CONTROL

NOTE: For further details of module configuration, refer to DSE Publication: 057-238 *DSE8610 MKII Configuration Suite PC Software Manual*.

Depending upon module configuration, the *Fuel Level* page may include a **Tick**  icon. This denotes that *Manual Fuel Pump Control* is available by pressing and holding the **Tick**  button.



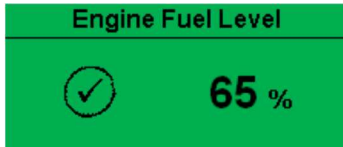





Example:



4.2.2.2 DPF REGENERATION LAMPS

NOTE: For further details of module configuration, refer to DSE Publication: 057-238 *DSE8610 MKII Configuration Suite PC Software Manual*.

Depending upon the *Engine Type* selected in the module's configuration, the *Engine* section may include the *DPF Regeneration Lamps* page. This page contains icons to show the status of various ECU functions, some of which are applicable to Tier 4 engine requirements. The icons flash at different rates to show the status of the ECU function, refer to the engine manufacturer for more information about this.

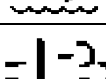
Icon	Fault	Description
	ECU Amber Alarm	The module received an Amber fault condition from the engine ECU.
	ECU Red Alarm	The module received a Red fault condition from the engine ECU.
	DPF Active	The module received a fault indication from the engine ECU informing that the <i>Diesel Particulate Filter</i> is active.
	DPF Inhibited	The module received a fault indication from the engine ECU informing that the <i>Diesel Particulate Filter</i> has been inhibited.
	DPF Stop	The module received a fault indication from the engine ECU informing that the <i>Diesel Particulate Filter</i> has been stopped.
	DPF Warning	The module received a fault condition from the engine ECU informing that the <i>Diesel Particulate Filter</i> has a fault condition.
	HEST Active	The module received a fault indication from the engine ECU informing that the <i>High Exhaust System Temperature</i> is active.
	DEF Low Level	The module received a fault condition from the engine ECU informing that the <i>Diesel Exhaust Fluid Low Level</i> is active.
	SCR Inducement	The module received a fault indication from the engine ECU informing that the <i>Selective Catalytic Reduction Inducement</i> is active.

Example:

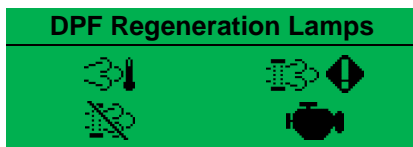

4.2.3 GENERATOR

Contains electrical values of the Generator, measured or derived from the module's voltage and current inputs.

Press the **Instrumentation Scroll**  buttons scroll through the **Generator** parameters.

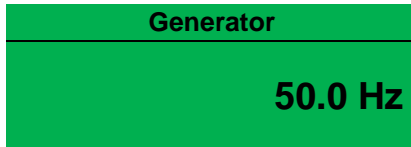

- Generator Voltage (Line to Neutral)
- Generator Voltage (Line to Line)
- Generator Frequency
- Generator Current (A)
- Generator Load Line to Neutral (kW)
- Generator Total Load (kW)
- Generator Load Line to Neutral (kVA)
- Generator Total Load (kVA)
- Generator Single Phase Power Factors
- Generator Power Factor Average
- Generator Load Line to Neutral (kvar)
- Generator Total Load (kvar)
- Generator Accumulated Load (kWh, kVAh, kvarh)
- Generator Loading Scheme
- Generator Phase Rotation
- Generator Nominal
- Generator Active Configuration
- Load Demand Priority
- Synchroscope display
- Commissioning Screens

4.2.3.1 COMMISSIONING SCREENS

 **NOTE: Some of the items may be removed from the commissioning screens if they are not applicable to the module configuration.**

Commissioning screens are available to both aid the commissioning process and also to give additional information about the synchronising and load sharing process. These screens are enabled and disabled in the module's display editor.

Commissioning Screen 1

L – L	0 V	kW	0.0	Average Line to Line V and total kW
Amps	0 A	kVAr	0.0	Load on the set and total kvar
Pf	-----	kW	0.0%	Power factor and percentage of full load kW
Gov	0.0%	Avr	0.0%	Gov and AVR % of Drive

Commissioning Screen 2

Tgt	0.0%	kW	0.0%	Generator target kW and actual kW percentage
Tgt	0.0%	kVAr	0.0%	Generator target kvar and actual kvar percentage
Pf	-----	Ramp	5.0%	Power factor and ramp rate
Gov	0.0%	Avr	0.0%	Gov and AVR % of Drive

4.2.3.2 SYNCHROSCOPE

▲ Note: If the module display is showing the status page when the synchronising process begins, the module will automatically switch to the Synchroscope page. The ramp progress will also be displayed on the screen once paralleling has taken place.

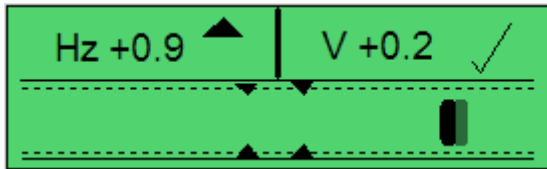

Initially the synchroscope display shows the difference between the bus and generator supplies. Here the display is showing a frequency mismatch of +0.9 Hz and a voltage mismatch of +0.2 V. The genset frequency is too high (indicated by the arrow) and must be reduced. The voltage is high, but is within the limits set for synchronising (indicated by the tick).

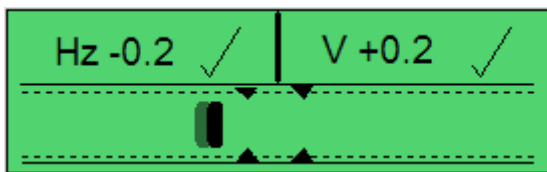

When both the frequency and the voltage differences are within acceptable limits, the phase matching begins. Then the moving bar shows the phase difference between the two supplies. The engine speed is automatically adjusted, altering the phase, until the moving bar enters the centre of the scope.



Once the bus and generator supplies are in sync, the module initiates a breaker close signal to the generator load switch closing the generator onto the bus. If synchronism is broken the moving bar will pass out of the synchronising window and the Out of Sync alarm activates. .

4.2.4 BUS

Contains electrical values of the common generator bus measured or derived from the module's bus inputs.

- Bus Voltage (Line to Neutral)
- Bus Voltage (Line to Line)
- Bus Frequency
- Bus Load kW
- Bus Load kVAR
- Bus Phase Sequence

4.2.5 EXPANSION

NOTE: Depending upon the module's configuration, some display screens may be disabled. For further details of module configuration, refer to DSE Publication: *057-243 DSE8610 MKII Configuration Suite PC Software Manual*.

Contains measured values from various input expansion modules that are connected to the DSE module.

Press the **Instrumentation Scroll**  buttons scroll through the **Expansion** parameters if configured.

Oil Temperature
80 °C
176 °F

- DSE2130 Analogue Inputs (Only appears if configured)
- DSE2131 Analogue Inputs (Only appears if configured)
- DSE2133 Analogue Inputs (Only appears if configured)

4.2.6 ALARMS

When an alarm is active, the *Internal Audible Alarm* sounds and the Common Alarm LED, if configured, illuminates.

The audible alarm is silenced by pressing the **Alarm Mute / Lamp Test**  button.

The LCD display jumps from the 'Information page' to display the Alarm Page

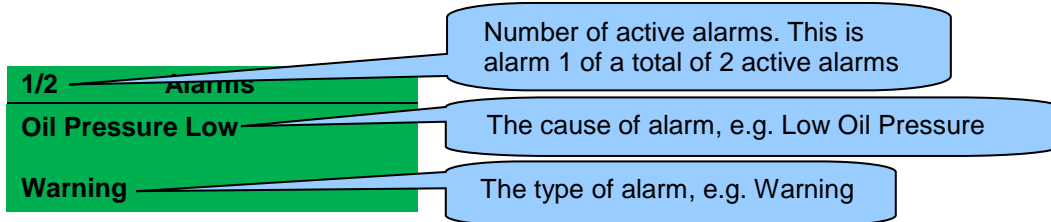

The LCD displays multiple alarms such as "*Coolant Temperature High*", "*Emergency Stop*" and "*Low Coolant Warning*". These automatically scroll in the order that they occurred or press the

Instrumentation Scroll  buttons scroll through manually.

In the event of an alarm, the LCD displays the appropriate text. If an additional alarm then occurs, the module displays the appropriate text.

Example:

1/2	Alarms
Low Oil Pressure	
Warning	

2/2	Alarms
Coolant Temp High	
Shutdown	

4.2.6.1 ECU ALARMS (CAN FAULT CODES / DTC)

 **NOTE:** For details on these code/graphic meanings, refer to the ECU instructions provided by the engine manufacturer, or contact the engine manufacturer for further assistance.

 **NOTE:** For further details on connection to electronic engines, refer to DSE Publication: *057-004 Electronic Engines And DSE Wiring*

When connected to a suitable CAN engine, the controller displays alarm status messages from the ECU in the *Alarms* section of the display.

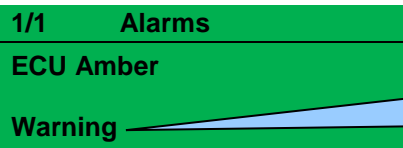

Type of alarm that is triggered on the DSE module, e.g. Warning



Press the **Next Page** button to access the list of *Current Engine DTCs* (Diagnostic Trouble Codes) from the ECU which are DM1 messages.

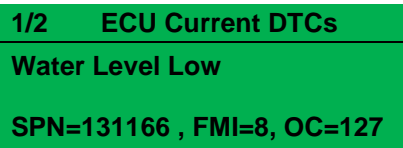

The DM1 DTC is interpreted by the module and is shown on the module's display as a text message. In addition to this, the manufacturer's DTC is shown below.

4.2.7 EVENT LOG

NOTE: For further details of module configuration, refer to DSE Publication: 057-238 *DSE8610 MKII Configuration Suite PC Software Manual.*

The module maintains a log of past alarms and/or selected status changes. The log size has been increased in the module over past module updates and is always subject to change. At the time of writing, the modules log is capable of storing the last 250 log entries.

Under default factory settings, the event log is configured to include all possible options; however, this is configurable by the system designer using the DSE Configuration Suite software.

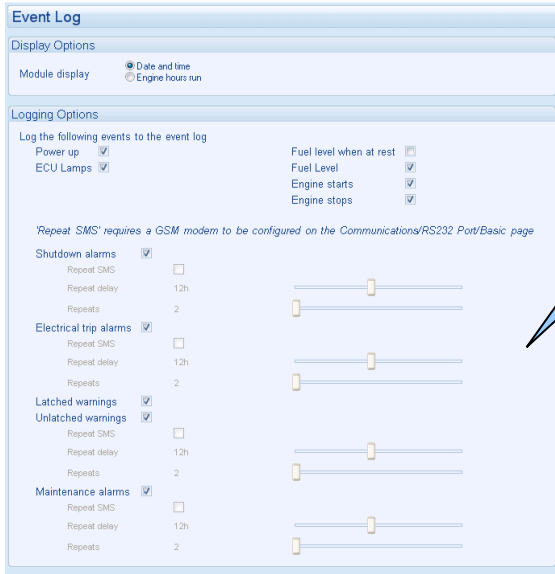



Example showing the possible configuration of the event log (DSE Configuration Suite Software).

This also shows the factory settings of the module.

When the event log is full, any subsequent event overwrites the oldest entry. Hence, the event log always contains the most recent events. The module logs the event type, along with the date and time (or engine running hours if configured to do so).

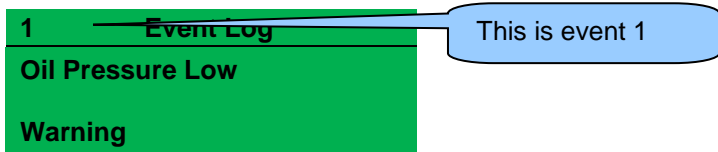
To view the event log, repeatedly press the **Next or Previous Page**  buttons until the LCD screen displays the *Event Log* page.



Press the **Scroll Down**  button to view the next most recent event.

Continuing to press the **Scroll Down**  button cycles through the past events after which, the display shows the most recent alarm and the cycle begins again.

To exit the event log and return to viewing the instruments, press the **Next or Previous Page**  buttons to select the next instrumentation page.

4.2.7.1 PROTECTIONS DISABLED

 **NOTE:** For further details on *Protections Disabled*, see section entitled *Protections* elsewhere in this manual.

Configuration is possible to prevent *Shutdown* and *Electrical Trip* alarms from stopping the generator. Under such conditions the operator is informed the events were blocked.

Example:

1	Event Log
	Oil Pressure Low
	Shutdown Blocked

4.2.7.2 RESET ELECTRICAL TRIP

 **NOTE:** For further details on *Reset Electrical Trip*, see section entitled *Protections* elsewhere in this manual.

Configuration is possible to enable the operator to reset *Electrical Trip* alarm a configurable number of times before the generator has stopped. This is to allow the generator to go back on load without having to perform a cooling run first. Under such conditions the operator is informed the events were overridden.

Example:

2	Event Log
	Gen Over Current
	Running Electrical Trip

4.2.8 SERIAL PORT

4.2.8.1 RS232 SERIAL PORT

This section is included to give information about the RS232 serial port and external modem (if connected).

The items displayed on this page change depending upon configuration of the module. Refer to the system supplier for further details.

NOTE: Factory Default settings are for the RS232 port to be enabled with no modem connected, operating at 19200 baud, MODBUS slave address 10.

Connected To an RS232 Telephone Modem

When the module is powered up, it sends 'initialisation strings' to the connected modem. It is important therefore that the modem is already powered, or is powered up at the same time as the module. At regular intervals after power up, the modem is reset, and reinitialised, to ensure the modem does not 'hang up'.

If the module does not correctly communicate with the modem, "Modem initialising" appears on the Serial Port instrument screen as shown overleaf.

If the module is set for "incoming calls" or for "incoming and outgoing calls", once the modem is dialled, it answers after two rings (using the factory setting 'initialisation strings'). Once the call is established, all data is passed between the dialling PC and the module.

If the module is set for "outgoing calls" or for "incoming and outgoing calls", then the module dials out whenever an alarm is generated.

NOTE: Not all alarms generate a dial out command; this is dependant upon module configuration of the event log. Any event configured to be recorded in the event log causes the modem to dial out to a PC.

Serial Port	
Baud	9600
SlaveID	10
Modem	

Press the **Scroll Down**  button view the modem status....

Indicates that the RS232 port is configured for modem use. It displays 'RS232' if no modem is configured.

Connected to an RS232 GSM Modem

When the module is powered up, it sends 'initialisation strings' to the connected modem. It is important therefore that the modem is already powered, or is powered up at the same time as the module. At regular intervals after power up, the modem is reset, and reinitialised, to ensure the modem does not 'hang up'.

If the module does not correctly communicate with the modem, "Modem initialising" appears on the Serial Port instrument screen as shown overleaf.

If the module is set for "incoming calls" or for "incoming and outgoing calls", once the modem is dialled, it answers after two rings (using the factory setting 'initialisation strings'). Once the call is established, all data is passed between the dialling PC and the module.

If the module is set for "outgoing calls" or for "incoming and outgoing calls", then the module dials out whenever an alarm is generated.

NOTE: Not all alarms generate a dial out command; this is dependant upon module configuration of the event log. Any event configured to be recorded in the event log causes the modem to dial out to a PC.

Many GSM modems are fitted with a status LED to show operator cell status and ringing indicator. These are a useful troubleshooting tool.

In the case of GSM connection problems, try calling the DATA number of the SIMCARD with an ordinary telephone. There should be two rings, followed by the modem answering the call and then 'squealing'. If this does not happen, check all modem connections and double check with the SIM provider that it is a DATA SIM and can operate as a data modem. DATA is NOT the same as FAX or GPRS and is often called Circuit Switched Data (CSD) by the SIM provider.

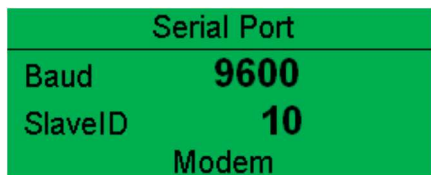

Press the **Scroll Down**  button view the modem GSM status....

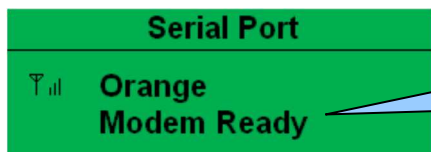

Currently connected GSM operator and signal strength.

NOTE: In the case of GSM modems, it is important that a DATA ENABLED SIM is used. This is often a different number than the 'voice number' and is often called Circuit Switched Data (CSD) by the SIM provider.

If the GSM modem is not purchased from DSE, ensure that it has been correctly set to operate at 9600 baud.

Modem Initialisation Sequence

The modem attempts to communicate to the module

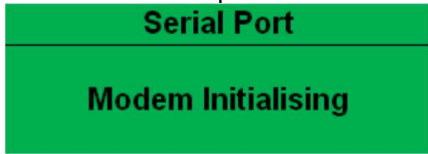

If the Modem and module communicate successfully:

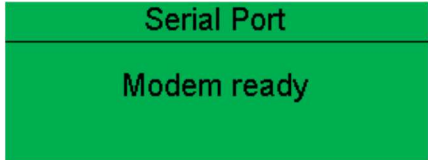

In case of communication failure between the modem and module, the modem is automatically reset and initialisation is attempted once more:

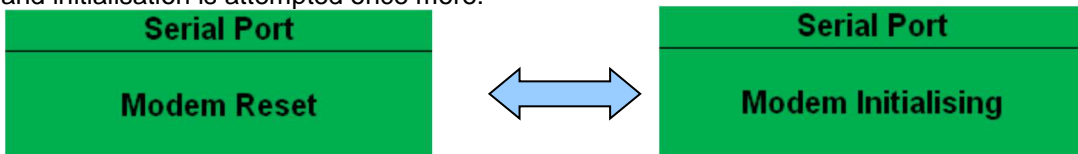

In the case of a module that is unable to communicate with the modem, the display continuously cycles between 'Modem Reset' and 'Modem Initialising' as the module resets the modem and attempts to communicate with it again, this continues until correct communication is established with the modem. In this instance, check connections and verify the modem operation.

Modem Diagnostics

Modem diagnostic screens are included; press the **Scroll Down** button when viewing the *RS232 Serial Port* instruments to cycle to the available screens. If experiencing modem communication problems, this information aids troubleshooting.

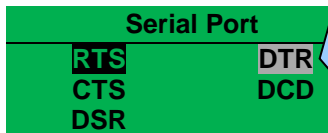

Shows the state of the modem communication lines. These can help diagnose connection problems.
 Example:
RTS A dark background shows the line is active.
RTS A grey background shows that the line is toggling high and low
RTS No background indicates that the line is inactive

Line	Description	
RTS	Request to Send	Flow Control
CTS	Clear to Send	Flow Control
DSR	Data Set Ready	Ready to Communicate
DTR	Data Terminal Ready	Ready to Communicate
DCD	Data Carrier Detect	Modem is Connected

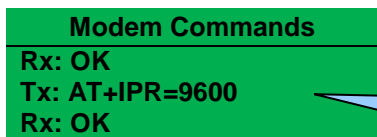

Shows the last command sent to the modem and the result of the command.

Connected to An RS232 MODBUS Master

The modules operate as a MODBUS RTU slave device. In a MODBUS system, there is only one Master, typically a PLC, HMI system or PC SCADA system.

This master requests for information from the MODBUS slave (The module) and may (in control systems) also send request to change operating modes etc. Unless the Master makes a request, the slave is 'quiet' on the data link.

The screenshot displays the configuration interface for the RS232 port. It is divided into two main sections: 'Basic' and 'Advanced'.
RS232 Port - Basic:
- Slave ID: 10
- Baud Rate: 19200
- Port Usage: No Modem
RS232 Port - Advanced:
- Initialisation Strings:
 - Init (not auto answer): E057=60S0=0&S0&C1&D3
 - Init (auto answer): E057=60S0=2&S0&C1&D3
 - Hangup: H0
- Connection Settings:
 - Master inactivity timeout: 5s
 - Connect delay: 60s
 - Retries: 4
 - Retry delay: 5s
 - Repeat cycle delay: 10s
- Modbus:
 - Inter-frame delay: 0 ms

The factory settings are for the module to communicate at 19200 baud, MODBUS slave address 10.

To use the RS232 port, ensure that 'port usage' is correctly set using the DSE Configuration Suite Software.

'Master inactivity timeout' should be set to at least twice the value of the system scan time. For example if a MODBUS master PLC requests data from the module once per second, the timeout should be set to at least 2 seconds

The DSE MODBUS document containing register mappings inside the DSE module is available upon request from support@deepseapl.com. Email the request along with the serial number of the DSE module to ensure the correct information is sent.

4.2.8.2 RS485 SERIAL PORT

This section is included to give information about the currently selected serial port

The items displayed on this page change depending upon configuration of the module. Refer to the system supplier for further details.

NOTE: Factory Default settings are for the RS485 port to operate at 19200 baud, MODBUS slave address 10.

Connected to an R485 MODBUS Master

The modules operate as a MODBUS RTU slave device. In a MODBUS system, there is only one Master, typically a PLC, HMI system or PC SCADA system.

Serial Port	
Baud	19200
SlaveID	1
RS485	

This master requests for information from the MODBUS slave (The module) and may (in control systems) also send request to change operating modes etc. Unless the Master makes a request, the slave is 'quiet' on the data link.

The factory settings are for the module to communicate at 115200 baud, MODBUS slave address 10.

RS485 Port

Basic

Slave ID

Baud Rate

Advanced

Master inactivity timeout 5s

Modbus

Inter-frame delay 0 ms

'Master inactivity timeout' should be set to at least twice the value of the system scan time. For example if a MODBUS master PLC requests data from the module once per second, the timeout should be set to at least 2 seconds.

The DSE MODBUS document containing register mappings inside the DSE module is available upon request from support@deepseapl.com. Email the request along with the serial number of the DSE module to ensure the correct information is sent.

Typical Requests (Using Pseudo Code)

BatteryVoltage=ReadRegister(10,0405,1): reads register (hex) 0405 as a single register (battery volts) from slave address 10.

WriteRegister(10,1008,2,35701, 65535-35701): Puts the module into AUTO mode by writing to (hex) register 1008, the values 35701 (auto mode) and register 1009 the value 65535-35701 (the bitwise opposite of auto mode)

Warning=(ReadRegister(10,0306,1) >> 11) & 1): reads (hex) 0306 and looks at bit 12 (Warning alarm present)

ElectricalTrip=(ReadRegister(10,0306,1) >> 10) & 1): reads (hex) 0306 and looks at bit 11 (Electrical Trip alarm present)

ControlMode=ReadRegister(10,0304,2): reads (hex) register 0304 (control mode).

4.2.9 ABOUT

4.2.9.1 MODULE INFORMATION

Contains important information about the module and the firmware versions. This information may be asked for when contacting DSE Technical Support Department for advice.

About	
Variant	8610 MKII
Application	V1.1.23
USB ID	11A6BAD2E

Variant: 86xx MKII

Application Version: The version of the module's main firmware file (Updatable using the Firmware Update Wizard in the DSE Configuration Suite Software).

USB ID: Unique identifier for PC USB connection



Press the **Scroll Down** button to access more information about the module.

About	
Bootloader	V3.0.19
Analogue	V1.1.0

Bootloader: Firmware Update bootloader software version

Analogue: Analogue measurements software version

About	
Engine Type	Volvo EMS2b
Version	V1.21

Engine Type: The name of the engine file selected in the configuration

Version: Engine type file version.

4.2.9.2 ETHERNET

Whilst in the 'ABOUT' section, press the **Scroll Down**  button to access more information about the network settings.

Network settings change be configured using DSE Configuration Suite Software. The module must be rebooted for the changes to take effect.

Network	
IP Address	192.168.50.76
DHCP	Disabled

- IP Address – The configured network IP address of the module
- DHCP – Dynamic Host Configuration Protocol (DHCP) has been enabled or disabled in the modules configuration.

Press the **Scroll Down**  button to access more information about the network settings.

Network	
Subnet Mask	255.255.255.0

- Subnet Mask – The configured network subnet mask of the module.

Network	
Gateway Address	192.168.49.76

- Gateway Address – The configured network gateway address of the module.

Network	
DNS Address	192.168.88.99

- DNS Address – The configured network DNS address of the module.

Network	
MAC Address	E8.A4.C1.0.A.C2

- MAC Address – The MAC address of the module, this cannot be changed and is unique to every Ethernet device.

DHCP	
Host Domain	Vender

- DHCP – The DHCP settings of module if configured.

MODBUS Over IP	
TCP Port	502
Pref IP	192.168.20.11

- TCP Port – The MODBUS TCP communication port number.
- Pref IP – The preferred connection IP address. The module can support up to 4 MODBUS TCP masters. If there is an additional request from another master with this IP address, it will be allowed to be the fifth MODBUS TCP master.

4.2.9.3 DATA LOGGING

Whilst in the 'ABOUT' section, press **Scroll Down**  button to access more information about the data logging settings.

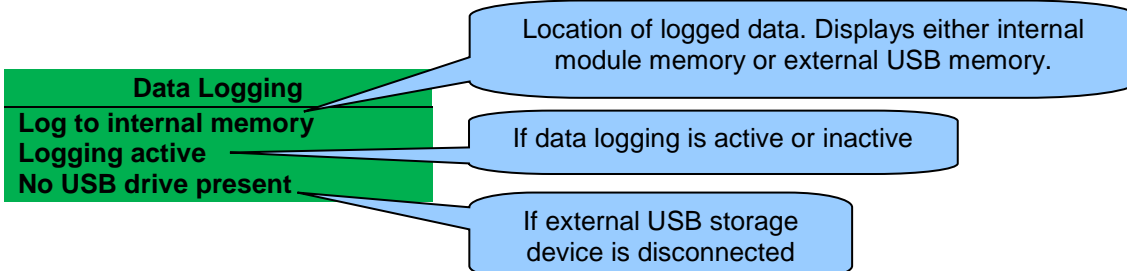

The screenshot shows the 'Data Logging' settings screen. The text on the screen is: 'Data Logging', 'Log to internal memory', 'Logging active', and 'No USB drive present'. Three callout boxes provide additional information: the first points to 'Log to internal memory' and says 'Location of logged data. Displays either internal module memory or external USB memory.'; the second points to 'Logging active' and says 'If data logging is active or inactive'; the third points to 'No USB drive present' and says 'If external USB storage device is disconnected'.

Inserting a USB storage device to the USB host connector on the rear of the module displays the following change to the page.

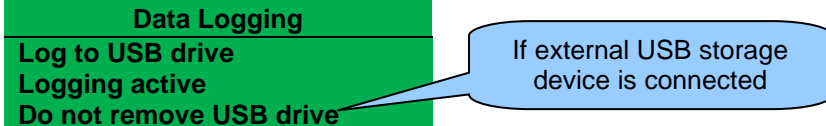

The screenshot shows the 'Data Logging' settings screen after a USB drive is inserted. The text on the screen is: 'Data Logging', 'Log to USB drive', 'Logging active', and 'Do not remove USB drive'. A callout box points to 'Do not remove USB drive' and says 'If external USB storage device is connected'.

 **NOTE: Removal of the USB drive should only be carried out using the following method.**

Press and hold the **Tick**  button until "Ok to remove USB drive" is displayed.

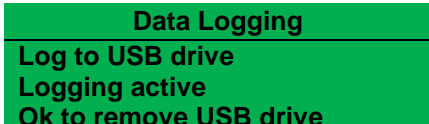

The screenshot shows the 'Data Logging' settings screen with the text: 'Data Logging', 'Log to USB drive', 'Logging active', and 'Ok to remove USB drive'.

It is now safe to remove the USB drive. This ensures the logging data file saves to memory complete and does not become corrupt.

Press **Scroll Down**  button to view the next page.

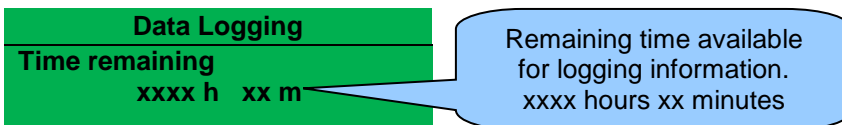

The screenshot shows the 'Data Logging' settings screen with the text: 'Data Logging', 'Time remaining', and 'xxxx h xx m'. A callout box points to 'xxxx h xx m' and says 'Remaining time available for logging information. xxxx hours xx minutes'.

Press **Scroll Down**  button to view the next page.

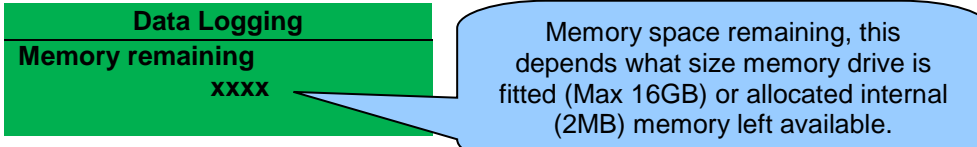

The screenshot shows the 'Data Logging' settings screen with the text: 'Data Logging', 'Memory remaining', and 'xxxx'. A callout box points to 'xxxx' and says 'Memory space remaining, this depends what size memory drive is fitted (Max 16GB) or allocated internal (2MB) memory left available.'

4.3 USER CONFIGURABLE INDICATORS

These LEDs are configured by the user to indicate any one of **100+ different functions** based around the following:

Indications - Monitoring of a digital input and indicating associated functioning user's equipment - *Such as Battery Charger On or Louvres Open, etc.*

Warnings, Electrical Trips & Shutdowns Alarms - Specific indication of a particular warning or shutdown condition, backed up by LCD indication - *Such as Low Oil Pressure Shutdown, Low Coolant level, etc.*

Status Indications - Indication of specific functions or sequences derived from the modules operating state - *Such as Safety On, Pre-heating, Panel Locked, etc.*



5 OPERATION

NOTE: The following descriptions detail the sequences followed by a module containing the standard 'factory configuration'. Always refer to your configuration source for the exact sequences and timers observed by any particular module in the field.

5.1 QUICKSTART GUIDE

This section provides a quick start guide to the module's operation.

5.1.1 STARTING THE ENGINE

NOTE: For further details, see the section entitled *Operation* elsewhere in this document.



5.1.2 STOPPING THE ENGINE

NOTE: For further details, see the section entitled *Operation* elsewhere in this document.





5.2 STOP/RESET MODE

 **NOTE:** If a digital input configured to *Panel Lock* is active, changing module modes is not possible. Viewing the instruments and event logs is NOT affected by *Panel Lock*.

 **NOTE:** For further details of module configuration, refer to DSE Publication: 057-238 *DSE8610 MKII Configuration Suite PC Software Manual*.

Stop/Reset Mode is activated by pressing the **Stop/Reset Mode**  button.

The LED above the **Stop/Reset Mode**  button illuminates to indicate **Stop/Reset Mode**  operation.

In **Stop/Reset Mode** , the module removes the generator from load (if necessary) before stopping the generator.

If the generator does not stop when requested, the *Fail To Stop* alarm is activated (subject to the setting of the *Fail to Stop* timer). To detect the engine at rest the following must occur:

- Engine speed is zero as detected by the CAN ECU
- Generator AC Voltage and Frequency must be zero.
- Engine Charge Alternator Voltage must be zero.
- Oil pressure sensor must indicate low oil pressure

When the engine has stopped and the module is in the **Stop/Reset Mode** , it is possible to send configuration files to the module from DSE Configuration Suite PC software and to enter the Front Panel Editor to change parameters.

Any latched alarms that have been cleared are reset when **Stop/Reset Mode**  is entered.

The engine is not started when in **Stop/Reset Mode** . If start signals are given, the input is ignored until **Auto Mode**  is entered.



When left in **Stop/Reset Mode**  with no presses of the fascia buttons, no form of communication active and configured for *Power Save Mode*, the module enters *Power Save Mode*. To 'wake' the module, press any fascia control buttons.

Power Save Mode in the DSE Configuration Suite Software

Power Save Mode Enable



5.2.1 ECU OVERRIDE

Pressing the **Start**  button in **Stop/Reset Mode**  powers up the engine's ECU but does not start the engine. This can be used to check the status of the CAN communication and to prime the fuel system.

5.3 MANUAL MODE

NOTE: If a digital input configured to Panel Lock is active, changing module modes is not possible. Viewing the instruments and event logs is NOT affected by panel lock.

Manual Mode is activated by pressing the **Manual Mode**  button.

The LED above the **Manual Mode**  button illuminates to indicate **Manual Mode**  operations.

In **Manual Mode**  the generator does not start automatically

To begin the starting sequence, press the **Start**  button.

5.3.1 STARTING SEQUENCE

NOTE: There is no *Start Delay* in this mode of operation.

NOTE: If the unit has been configured for CAN, compatible ECU's receives the start command via CAN.

NOTE: For further details of module configuration, refer to DSE Publication: 057-238 *DSE8610 MKII Configuration Suite PC Software Manual*.

The fuel relay is energised and the engine is cranked.

If the engine fails to fire during this cranking attempt then the starter motor is disengaged for the *Crank Rest Timer* duration after which the next start attempt is made. Should this sequence continue beyond the set *Number Of Attempts*, the start sequence is terminated and the display shows *Fail to Start*.

The starter motor is disengaged when the engine fires. Speed detection is factory configured to be derived from the AC alternator output frequency, but can additionally be measured from a Magnetic Pickup mounted on the flywheel or from the CANbus link to the engine ECU depending on module configuration.

Additionally, rising oil pressure can be used to disconnect the starter motor (but cannot detect underspeed or overspeed).

After the starter motor has disengaged, the *Safety On Delay* timer activates, allowing Oil Pressure, High Engine Temperature, Under-speed, Charge Fail and any delayed Auxiliary fault inputs to stabilise without triggering the fault.

5.3.2 ENGINE RUNNING





 **NOTE: The load transfer signal remains inactive until the generator is available. This prevents excessive wear on the engine and alternator.**

In **Manual Mode** , the generator does not synchronise and close it's load switch unless a 'loading request' is made.

A loading request can come from a number of sources.



- Press the **Close Generator**  button.
- Activation of the inbuilt exercise scheduler if configured for 'on load' runs.
- Activation of an auxiliary input that has been configured to *Remote Start On Load* or *Remote Start On Load Demand*
- Request from a DSExx60 or from another DSExx10 controller over the MSC link.
- Instruction from external remote telemetry devices using the RS232, RS485 or Ethernet interface.

Once the generator has been instructed to synchronise and placed on load, it is not automatically removed. To instruct the generator to ramp its load off and open its load switch either:

- Press the **Open Generator** 
- Press the **Auto Mode**  button to return to automatic mode. The set observes all **Auto Mode**  start requests and stopping timers before beginning the *Auto Mode Stopping Sequence*.
- Press the **Stop/Reset Mode**  button to remove load and stop the generator.
- Activation of an auxiliary input that has been configured to *Generator Load Inhibit* (no ramping occurs).



5.3.3 STOPPING SEQUENCE



In **Manual Mode**  the set continues to run until either:

- The **Stop/Reset Mode**  button is pressed – The delayed load outputs are de-activated immediately and the set immediately stops.
- The **Auto Mode**  button is pressed. The set observes all **Auto Mode**  start requests and stopping timers before beginning the *Auto Mode Stopping Sequence*.

5.4 AUTOMATIC MODE

 **NOTE:** If a digital input configured to external *Panel Lock* is active, changing module modes is not possible. Viewing the instruments and event logs is NOT affected by *Panel Lock*.

Auto Mode  is activated by pressing the **Auto Mode**  button.

The LED above the **Auto Mode**  button illuminates to indicate **Auto Mode**  operations.

Auto Mode  allows the generator to operate fully automatically, starting and stopping as required with no user intervention.

5.4.1 WAITING IN AUTO MODE

If a starting request is made, the starting sequence begins. Starting requests can be from the following sources:

- Activation of the inbuilt exercise scheduler.
- Activation of an auxiliary input that has been configured to *Remote Start On Load*, *Remote Start On Load Demand* or *Remote Start Off Load*.
- Request from a DSExx60 or from another DSExx10 controller over the MSC link.
- Instruction from external remote telemetry devices using the RS232, RS485 or Ethernet interface.

5.4.2 STARTING SEQUENCE

 **NOTE:** If the unit has been configured for CAN, compatible ECU's receive the start command via CAN and transmit the engine speed to the DSE controller.

 **NOTE:** For further details of module configuration, refer to DSE Publication: 057-238 *DSE8610 MKII Configuration Suite PC Software Manual*.

To allow for 'false' start requests, the *Start Delay* timer begins.

Should all start requests be removed during the *Start Delay* timer, the unit returns to a stand-by state.

If a start request is still present at the end of the *Start Delay* timer, the fuel relay is energised and the engine is cranked.

If the engine fails to fire during this cranking attempt then the starter motor is disengaged for the *Crank Rest* duration after which the next start attempt is made. Should this sequence continue beyond the *Set Number Of Attempts*, the start sequence is terminated and the display shows *Fail to Start*.

The starter motor is disengaged when the engine fires. Speed detection is factory configured to be derived from the AC alternator output frequency, but can additionally be measured from a Magnetic Pickup mounted on the flywheel or from the CAN link to the engine ECU depending on module.

Additionally, rising oil pressure can be used to disconnect the starter motor (but cannot detect underspeed or overspeed).

After the starter motor has disengaged, the *Safety On Delay* timer activates, allowing Oil Pressure, High Engine Temperature, Under-speed, Charge Fail and any delayed Auxiliary fault inputs to stabilise without triggering the fault.

5.4.3 ENGINE RUNNING

 **NOTE: The load transfer signal remains inactive until the generator is available. This prevents excessive wear on the engine and alternator.**

The generator synchronises to the bus and is placed on load if configured to do so.

If all start requests are removed, the *Stopping Sequence* begins.

5.4.4 STOPPING SEQUENCE

The *Return Delay* timer operates to ensure that the starting request has been permanently removed and isn't just a short term removal. Should another start request be made during the cooling down period, the set returns on load.

If there are no starting requests at the end of the *Return Delay* timer, the generator ramps its load off and open its load switch, the *Cooling Down* timer is initiated.

The *Cooling Down* timer allows the set to run off load and cool sufficiently before being stopped. This is particularly important where turbo chargers are fitted to the engine.

After the *Cooling Down* timer has expired, the set is stopped.

5.5 SCHEDULER

The controller contains an inbuilt exercise run scheduler, capable of automatically starting and stopping the set or inhibiting the set from starting. Up to 16 scheduled start/stop sequences can be configured to repeat on a 7-day or 28-day cycle.

Scheduled runs may be on load or off load depending upon module configuration.

Example:

Screen capture from DSE Configuration Suite Software showing the configuration of the Exercise Scheduler.

In this example the set starts at 09:00 on Monday and run for 5 hours on load, then again on Tuesday at 09:00 and run for 5 hours on load

Week	Day	Start Time	Duration	Clear	Week	Day	Start Time	Duration	Clear
First	Monday	09:00	05:00	Clear	First	Monday	00:00	00:00	Clear
First	Tuesday	09:00	05:00	Clear	First	Monday	00:00	00:00	Clear
First	Monday	00:00	00:00	Clear	First	Monday	00:00	00:00	Clear
First	Monday	00:00	00:00	Clear	First	Monday	00:00	00:00	Clear
First	Monday	00:00	00:00	Clear	First	Monday	00:00	00:00	Clear
First	Monday	00:00	00:00	Clear	First	Monday	00:00	00:00	Clear
First	Monday	00:00	00:00	Clear	First	Monday	00:00	00:00	Clear
First	Monday	00:00	00:00	Clear	First	Monday	00:00	00:00	Clear
First	Monday	00:00	00:00	Clear	First	Monday	00:00	00:00	Clear
First	Monday	00:00	00:00	Clear	First	Monday	00:00	00:00	Clear
First	Monday	00:00	00:00	Clear	First	Monday	00:00	00:00	Clear
First	Monday	00:00	00:00	Clear	First	Monday	00:00	00:00	Clear
First	Monday	00:00	00:00	Clear	First	Monday	00:00	00:00	Clear
First	Monday	00:00	00:00	Clear	First	Monday	00:00	00:00	Clear

5.5.1 STOP MODE

- Scheduled runs do not occur when the module is in **Stop/Reset Mode**

5.5.2 MANUAL MODE

- Scheduled runs do not occur when the module is in **Manual Mode**
- Activation of a Scheduled Run 'On Load' when the module is operating Off Load in **Manual Mode** forces the set to run On Load.

5.5.3 AUTO MODE

- Scheduled runs operate only if the module is in **Auto Mode**
- If the module is in **Stop/Reset Mode** or **Manual Mode** when a scheduled run begins, the engine is not started. However, if the module is moved into **Auto Mode** during a scheduled run, the engine is called to start.
- Depending upon configuration by the system designer, an external input can be used to inhibit a scheduled run.
- If the engine is running *Off Load* in **Auto Mode** and a scheduled run configured to 'On Load' begins, the set is placed *On Load* for the duration of the Schedule.

5.6 MSC COMPATIBILITY MODE

NOTE: These settings enable the interface between the DSE86xx MKII controllers and the legacy DSE55xx and DSE75xx controllers.

Parameter	Description
MSC Compatibility	<p>NOTE: The DSE5560 and DSE7560 are not compatible with the DSE8660 MKII, only one type of DSExx60 can be connected on the MSC at any time (DSE5560/DSE7560 OR DSE8660 MKII).</p> <p><input type="checkbox"/> = The DSE86xx MKII is not be able to communicate with the DSE55xx and DSE75xx series modules on the MSC Link. <input checked="" type="checkbox"/> = Communication between DSE86xx MKII and DSE55xx/DSE75xx is enabled. The maximum number of DSExx10 controllers is reduced to 16 and the maximum number of DSExx60 controllers is reduced to 8.</p>
P123 Ramp Enabled	<p>NOTE: The P123 is only available for DSExx10 MKII modules.</p> <p><input type="checkbox"/> = The DSE8610 MKII uses MSC link for connection to other DSE modules for ramping and load sharing. <input checked="" type="checkbox"/> = The DSE8610 MKII is connected to a DSE123 using the MSC link to convert the MSC link to interface with Analogue Load Share lines</p>
P123 Frequency Trip	<p>(Only Available when P123 Ramp option is enabled) If the frequency changes by this amount when ramping down, the module opens the generator breaker.</p>

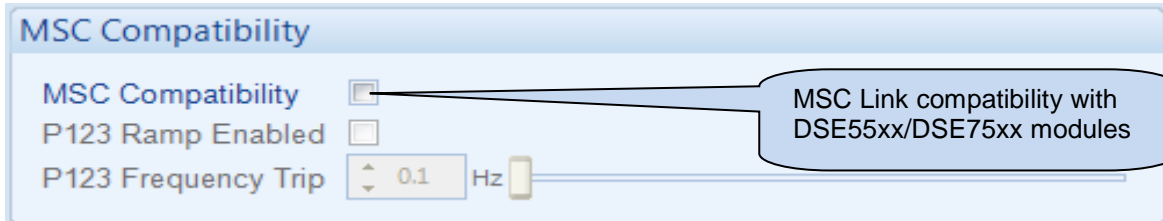

5.7 ALTERNATIVE CONFIGURATIONS

Depending upon the configuration of the system by the generator supplier, the system may have selectable configurations (for example to select between 50 Hz and 60 Hz). If this has been enabled the generator supplier will advise how this selection can be made (usually by operating an external selector switch or by selecting the required configuration file in the module's front panel configuration editor).

5.8 DUMMY LOAD / LOAD SHEDDING CONTROL

If the load is low, 'dummy loads' (typically resistive load banks) are introduced to ensure the engine is not too lightly loaded. Conversely, as the load increases towards the maximum rating of the set, non-essential loads are shed to prevent overload of the generator.

5.8.1 DUMMY LOAD CONTROL

The *Dummy Load Control* feature (if enabled) allows for a maximum of five dummy load steps. When the set is first started, all configured *Dummy Load Control* outputs are de-energised. Once the generator is placed onto load, the generator loading is monitored by the *Dummy Load Control* scheme.

If the generator loading falls below the *Dummy Load Control Trip* setting (kW), the *Dummy Load Control Trip Delay* begins. If the generator loading remains at this low level for the duration of the timer, the first *Dummy Load Control* output is energised. This is used to energise external circuits to switch in a resistive load bank.

The first dummy load has increased the generator loading. Again, the generator loading is monitored. This continues until all configured *Dummy Load Control* outputs are energised.

When the generator loading rises above the *Dummy Load Return* level, the *Dummy Load Return Delay* begins. If the generator loading remains at these levels after the completion of the timer, the 'highest' active *Dummy Load Control* output is de-energised. This continues until all *Dummy Load Control* outputs have been de-energised.

When the generator enters a stopping sequence for any reason, all the *Dummy Load Control* outputs de-energise at the same time as the generator load switch is signalled to open.

Example screen shot of *Dummy Load Control* setup in the DSE Configuration Suite

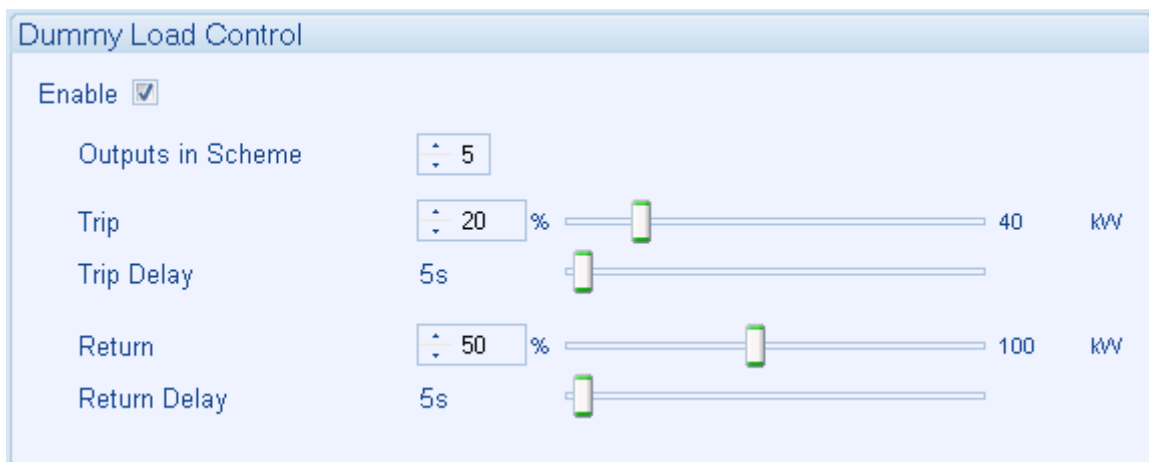

5.8.2 LOAD SHEDDING CONTROL

The *Load Shedding Control* feature (if enabled) allows for a maximum of five load shedding steps. When the generator is about to take load, the configured number of *Load Shedding Control Outputs at Start* will energise. This allows certain non-essential loads to be removed prior to the generator's load switch being closed. This is used to ensure the initial loading of the generator is kept to a minimum, below the *Load Acceptance* specification of the generator.

The generator is then placed on load. The *Load Shedding Control* scheme begins. When the generator loading exceeds the *Load Shedding Trip* level the *Trip Delay* timer will start. If the generator loading is still high when the timer expires, the first *Load shedding Control* output energises. When the generator loading has been above the trip level for the duration of the timer the 'next' *Load Shedding Control* output energises and so on until all *Load Shedding Control* outputs are energised.

When the generator loading falls below the *Load Shedding Return* level, the *Return Delay Time* starts. If the generator load remains below the *Load Shedding Return* level when the timer has expired, the 'highest' *Load Shedding Control* output de-energises. This process continues until all outputs have been de-energised.

When the generator enters a stopping sequence for any reason, all the *Load Shedding Control* outputs de-energise at the same time as the generator load switch is signalled to open.



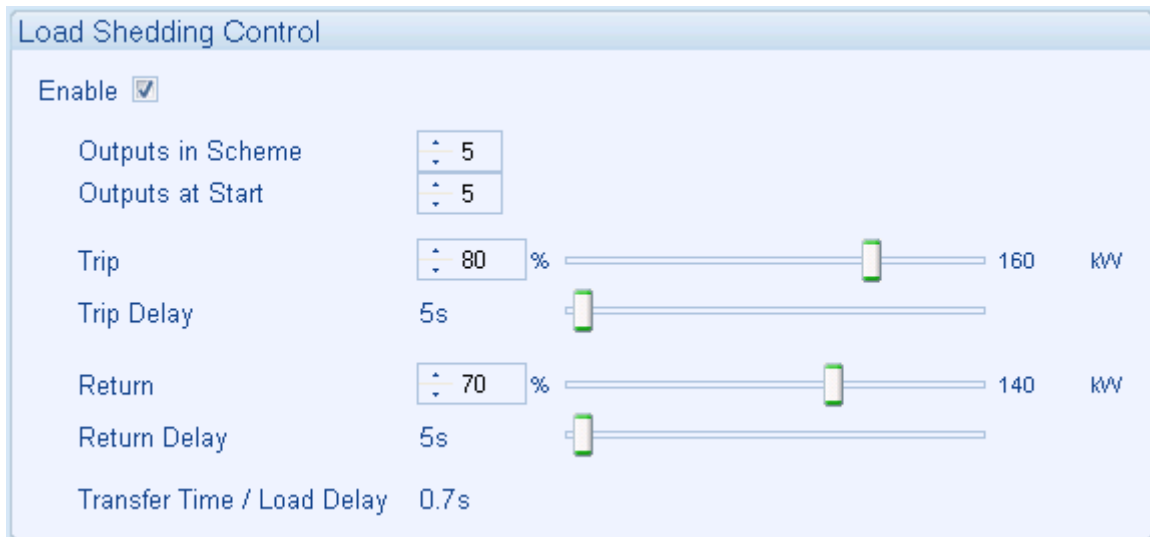

Example screen shot of *Load Shedding Control* setup in the DSE Configuration Suite:



5.9 SMS CONTROL

The *SMS Control* feature (if enabled) allows the user to send control commands to the module via SMS message. There are five control commands that the user is able to send to the module shown in the table below.

NOTE: Multiple SMS Control Commands CANNOT be sent in a single SMS message.



Control Command Number	Module Action
1	Start the generator and run off load if the controller is in the Auto Mode  .
2	Start the generator and run on load if the controller is in the Auto Mode  .
3	Cancel the SMS start request leaving the module in its current operating mode.
4	Put the module into the Stop/Reset Mode  .
5	Put the module into the Auto Mode  .

To send an SMS command, the user requires (if configured) the *SMS Control Pin* and the *Control Command Number*. Only these numbers must be included in the SMS, the module does not respond to any SMS with extra characters or missing PIN (if configured). Below is an example showing how to start and run the generator on load by SMS message.

NOTE: There MUST be a space between the SMS PIN and the Control Command Number

PIN

Control Command Number

SMS Message 1 0123 5	This SMS message places the module into the Auto Mode  .
SMS Message 2 0123 2	This SMS message will start generator and run it on load.
SMS Message 3 0123 3	This SMS message will remove the start and run command given by the previous SMS message and leave the module in the Auto Mode  .
SMS Message 4 0123 4	This SMS message will place the module into the Stop/Reset Mode  .

Example screenshot of *SMS Control* setup in the DSE Configuration Suite:



5.10 DEAD BUS SYNCHRONISING (AUTO MODE)

 **NOTE:** For further details on Dead Bus Synchronising, refer to DSE Publication: 056-072 *Dead Bus Synchronising Training Document*.

5.10.1 BENEFIT OF SYSTEM

Generator set specifications often contain the requirement for the set to be on load within 15 seconds of a mains supply failure. This is easily achievable in single set applications. However in the current era of fuel conservation, multiple sets are often used to provide the backup power solution for many applications. This gives challenges in starting and synchronising the required sets before they can be used to power the load.

The solution to this is a longstanding one, having being used for many decades. However modern digital communications such as the DSE MSC link has vastly improved the control and hence safety of the system operation. The solution is called *Dead Bus Synchronising*. Using *Dead Bus Synchronising*, any number of generators are able to be online and in parallel potentially within 15 seconds, depending upon applications and hardware used.

5.10.2 HARDWARE REQUIREMENTS

- DSE8610 MKII controller.
- DC controlled generator load switch.
- Auxiliary contact to feed back generator breaker status to the DSE controller.
- External relay driven by the DSE module to isolate the supply to the AVR inside the generator's alternator.
- Speed detection using an MPU or CAN signal.

5.10.3 OPERATION

Before the generator sets are started, their load switches are closed. As there is no AC supply the load switches must be DC controlled. Next, the alternator excitation field is disabled by isolating the supply to the AVR's. The engines are all started at the same time and allowed for the *Excitation Delay* timer to reach the desired operating speed. As there is no AC supply generated, frequency cannot be used to determine engine speed, hence the requirement for an MPU of CAN speed signal.

If the engines have attained the desired engine speed within the *Excitation Delay* timer, the AVR's power supply is reconnected, enabling the excitation field and load sharing begins. The MSC link is used to ensure all sets excite their alternators at exactly the same time. Any generators not up to speed before the end of the *Excitation Delay* timer are instructed to open their load switches. A short time later, these sets synchronise to the bus in the traditional manner.

Status	
Start Delay	00:00 s

The generator load switch is closed, excitation is switched off, start delay if configured.

Status	
Fuel	

Fuel output is activated

Status	
Crank Attempt	

Engine is cranked

Status	
Excitation Delay	00:03
L-N	0 V 0 A
L-L	0 V 0 Hz
kW	0 kW 0 pf

Excitation Delay before excitation output is activated. Generators run up to speed if any on the MSC are out of limits they are instructed to open their load switches and synchronise in the normal manner.

Status	
Excitation Delay	00:00
L-N	230 V 174 A
L-L	400 V 50 Hz
kW	100 kW 0.8 pf

Excitation output closed & voltage rises to nominal settings.

Status	
On Load	

Once the voltage and frequency are within configurable limits the set(s) can take load.

6 PROTECTIONS

6.1 ALARMS

When an alarm is active, the *Internal Audible Alarm* sounds and the *Common Alarm* output if configured, activates.

The audible alarm is silenced by pressing the **Alarm Mute / Lamp Test**  button.

The LCD display jumps from the 'Information page' to display the Alarm Page

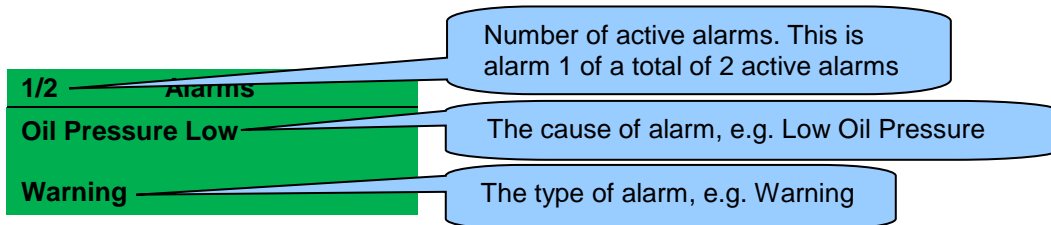

The LCD displays multiple alarms such as "*Coolant Temperature High*", "*Emergency Stop*" and "*Low Coolant Warning*". These automatically scroll in the order that they occurred or press the

 **Instrumentation Scroll** buttons to scroll through manually.

In the event of an alarm, the LCD displays the appropriate text. If an additional alarm then occurs, the module displays the appropriate text.

Example:

1/2	Alarms
Oil Pressure Low	
Warning	

2/2	Alarms
Coolant Temp High	
Shutdown	

6.1.1 PROTECTIONS DISABLED

Configuration is possible to prevent *Shutdown* and *Electrical Trip* alarms from stopping the generator. Under such conditions, *Protections Disabled* appears on the module display to inform the operator. *Shutdown* and *Electrical Trip* alarms still appear however, the operator is informed the alarms are blocked.

Example:

1/1	Alarms
Oil Pressure Low	
Shutdown Blocked	

This feature is provided to assist the system designer in meeting specifications for *Warning Only*, *Protections Disabled*, *Run to Destruction*, *War Mode* or other similar wording.

When configuring this feature in the PC software, the system designer chooses to make the feature permanently active or only active upon operation of an external switch. The system designer provides this switch (not DSE) so its location varies depending upon manufacturer, however it normally takes the form of a key operated switch to prevent inadvertent activation. Depending upon configuration, a warning alarm may be generated when the switch is operated.

The feature is configurable in the PC configuration software for the module. Writing a configuration to the controller that has "Protections Disabled" configured, results in a warning message appearing on the PC screen for the user to acknowledge before the controller's configuration is changed. This prevents inadvertent activation of the feature.

6.1.2 RESET ELECTRICAL TRIP

Configuration is possible to enable the operator to reset *Electrical Trip* alarm a configurable number of times before the generator has stopped. This is to allow the generator to go back on load without having to perform a cooling run first.



It is also possible to prevent an *Electrical Trip* alarm from stopping the generator. Under such conditions, the *Electrical Trip Stop Inhibited Warning* alarm appears on the module display to inform the operator. *Electrical Trip* alarms still appear however, the operator is just informed the generator is inhibited from stopping.

Example:

1/2	Alarms
	Electrical Trip Stop Inhibited
	Warning

2/2	Alarms
	Gen Over Current
	Electrical Trip

This feature is provided to assist the system designer in meeting specifications requirements to ensure the generator (if running) is able to take load again after the alarm has been reset. Depending upon configuration, the generator may go into a cooling run or be inhibited from stopping after the *Electrical Trip* alarm activates.

When configuring this feature in the PC software, the system designer chooses to make the *Electrical Trip* alarms resettable by using a switch connected to an input configured for *Reset Electrical Trip* and/or by pressing the **Close Generator**  button. The system designer provides this switch (not DSE) so its location varies depending upon manufacturer, however it normally takes the form of a key operated switch to prevent inadvertent activation. If the DSE module is in the **Manual Mode** , a further press of the **Close Generator**  button is required to place the generator on load if no other on load request is active.

The feature is configurable in the PC configuration software for the module. Writing a configuration to the controller that has *Reset Electrical Trip* enabled, results in a warning message appearing on the PC screen for the user to acknowledge before the controller's configuration is changed. This prevents inadvertent activation of the feature.

6.1.3 ECU ALARMS (CAN FAULT CODES / DTC)

NOTE: For details on these code meanings, refer to the ECU instructions provided by the engine manufacturer, or contact the engine manufacturer for further assistance.

NOTE: For further details on connection to electronic engines, refer to DSE Publication: **057-004 Electronic Engines And DSE Wiring**

When connected to a suitable CAN engine, the controller displays alarm status messages from the ECU in the *Alarms* section of the display.



Type of alarm that is triggered on the DSE module, e.g. Warning



Press the **Next Page** button to access the list of *ECU Current DTCs* (Diagnostic Trouble Codes) from the ECU which are DM1 messages.

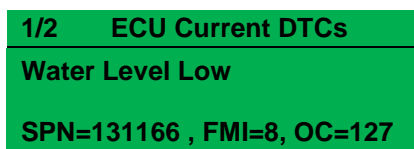

The DM1 DTC is interpreted by the module and is shown on the module's display as a text message. In addition to this, the manufacturer's DTC is shown below.



Press the **Next Page** button to access the list of *ECU Prev. DTCs* (Diagnostic Trouble Codes) from the ECU which are DM2 messages.

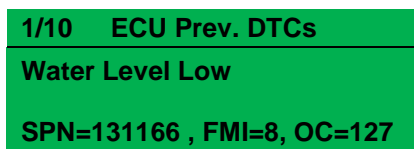

The DM2 DTC is interpreted by the module and is shown on the module's display as a text message. In addition to this, the manufacturer's DTC is shown below.

6.2 INDICATIONS

Indications are non-critical and often status conditions. They do not appear on the LCD display of the module as a text message in the *Status*, *Event Log* or *Alarms* pages. However, an output or LED indicator is configured to draw the operator's attention to the event.

Example:

- Input configured for indication.
- The LCD text does not appear on the module display but can be added in the configuration to remind the system designer what the input is used for.
- As the input is configured to *Indication* there is no alarm generated.
- LED Indicator 1 illuminates when Digital Input A is active.
- The Insert Card Text allows the system designer to print an insert card detailing the LED function.
- Example showing operation of the LED.



6.3 WARNING ALARMS

Warnings are non-critical alarm conditions and do not affect the operation of the engine system, they serve to draw the operators attention to an undesirable condition.

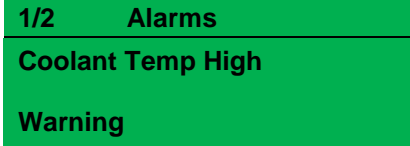

Example:



In the event of an alarm the LCD jumps to the alarms page, and scroll through all active alarms.

By default, warning alarms are self-resetting when the fault condition is removed. However enabling *All Warnings Are Latched* causes warning alarms to latch until reset manually. This is enabled using the DSE Configuration Suite in conjunction with a compatible PC.

If the module is configured for **CAN** and receives an “error” message from the ECU, ‘ECU Warning’ is shown on the module’s display as a warning alarm.

Fault	Description
2130 ID 1 to 4 Analogue Input E to H High	<p> NOTE: Due to module configuration the alarm message that appears on the display may be different. For further details of module configuration, refer to DSE Publication: 057-238 DSE8610 MKII Configuration Suite PC Software Manual.</p> <p>The module detected that an analogue input value of a DSE2130 had risen above the <i>Flexible Sensor High Pre-Alarm Trip</i> level.</p>
2130 ID 1 to 4 Analogue Input E to H Low	<p> NOTE: Due to module configuration the alarm message that appears on the display may be different. For further details of module configuration, refer to DSE Publication: 057-238 DSE8610 MKII Configuration Suite PC Software Manual.</p> <p>The module detected that an analogue input value of a DSE2130 had fallen below the <i>Flexible Sensor Low Pre-Alarm Trip</i> level.</p>





Continued over page...

Fault	Description
2130 ID1 to 4 Digital Input A to H	<p>▲ NOTE: Due to module configuration the alarm message that appears on the display may be different. For further details of module configuration, refer to DSE Publication: <i>057-238 DSE8610 MKII Configuration Suite PC Software Manual</i>.</p> <p>The module detected that a digital input configured to create a fault condition on a DSE2130 expansion module became active and the appropriate LCD message displayed.</p>
2131 ID 1 to 4 Analogue Input A to J High	<p>▲ NOTE: Due to module configuration the alarm message that appears on the display may be different. For further details of module configuration, refer to DSE Publication: <i>057-238 DSE8610 MKII Configuration Suite PC Software Manual</i>.</p> <p>The module detected that an analogue input value of a DSE2131 had risen above the <i>Flexible Sensor High Pre-Alarm Trip</i> level.</p>
2131 ID 1 to 4 Analogue Input A to J Low	<p>▲ NOTE: Due to module configuration the alarm message that appears on the display may be different. For further details of module configuration, refer to DSE Publication: <i>057-238 DSE8610 MKII Configuration Suite PC Software Manual</i>.</p> <p>The module detected that an analogue input value of a DSE2131 had fallen below the <i>Flexible Sensor Low Pre-Alarm Trip</i> level.</p>
2131 ID 1 to 4 Analogue Input A to J	<p>▲ NOTE: Due to module configuration the alarm message that appears on the display may be different. For further details of module configuration, refer to DSE Publication: <i>057-238 DSE8610 MKII Configuration Suite PC Software Manual</i>.</p> <p>The module detected that a digital input configured to create a fault condition on a DSE2131 expansion module became active and the appropriate LCD message displayed.</p>
2133 ID 1 to 4 Analogue Input A to H High	<p>▲ NOTE: Due to module configuration the alarm message that appears on the display may be different. For further details of module configuration, refer to DSE Publication: <i>057-238 DSE8610 MKII Configuration Suite PC Software Manual</i>.</p> <p>The module detected that an analogue input value of a DSE2133 had risen above the <i>Flexible Sensor High Pre-Alarm Trip</i> level.</p>
2133 ID 1 to 4 Analogue Input A to H Low	<p>▲ NOTE: Due to module configuration the alarm message that appears on the display may be different. For further details of module configuration, refer to DSE Publication: <i>057-238 DSE8610 MKII Configuration Suite PC Software Manual</i>.</p> <p>The module detected that an analogue input value of a DSE2133 had fallen below the <i>Flexible Sensor Low Pre-Alarm Trip</i> level.</p>



Continued over page...

Fault	Description
Analogue Input A to D (Digital)	<p>▲ NOTE: Due to module configuration the alarm message that appears on the display may be different. For further details of module configuration, refer to DSE Publication: 057-238 DSE8610 MKII Configuration Suite PC Software Manual.</p> <p>The module detected that an analogue input configured as a digital input to create a fault condition became active and the appropriate LCD message is displayed.</p>
AVR Maximum Trim Limit	The module's AVR output has reached its limit whilst attempting to control the generator to produce more kvars whilst in parallel. This indicates a fault with either the AVR (including connection error), setting of SW2, or that the alternator has reached its maximum capacity.
Battery High Voltage IEEE 37.2 – 59 DC Overvoltage Relay	The module detected that its DC supply voltage had risen above the <i>Plant Battery Overvolts Warning Trip</i> level for the configured delay timer.
Battery Low Voltage IEEE 37.2 – 27 DC Undervoltage Relay	The module detected that its DC supply voltage had fallen below the <i>Plant Battery Undervolts Warning Trip</i> level for the configured delay timer.
Calibration Fault	The module detected that its internal calibration has failed. The unit must be sent back to DSE to be investigated and repaired. Contact DSE Technical Support for more details.
Charge Alt Failure IEEE 37.2 – 27 DC Undervoltage Relay	The module detected that the output voltage of the charge alternator had fallen below the <i>Charge Alternator Warning Trip</i> level for the configured delay timer.
Coolant Temp High IEEE C37.2 – 26 Apparatus Thermal Device	The module detected that the engine coolant temperature had risen above the <i>High Coolant Temperature Pre-Alarm Trip</i> level after the <i>Safety On Delay</i> timer had expired.
DEF Level Low	The module received a fault condition from the engine ECU alerting about the DEF level.
Digital Input A to L	<p>▲ NOTE: Due to module configuration the alarm message that appears on the display may be different. For further details of module configuration, refer to DSE Publication: 057-238 DSE8610 MKII Configuration Suite PC Software Manual.</p> <p>The module detected that a digital input configured to create a fault condition became active and the appropriate LCD message is displayed.</p>
DPTC Filter	The module received a fault condition from the engine ECU alerting that the DPF/DPTC had activated.
Earth Fault IEEE C37.2 – 51G or 51N Generator IDMT Earth Fault Relay	<p>▲ NOTE: For more details, see section entitled Earth Fault IDMT Alarm elsewhere in this document.</p> <p>The module detected that the generator earth fault current had risen above the <i>Earth Fault Trip Level</i> for the duration of the IDMT function.</p>
ECU Amber	The module received an amber fault condition from the engine ECU.
ECU Data Fail	The module is configured for CAN operation but has not detected data being sent from the engine's ECU.
ECU Malfunction.	The module received a malfunction fault condition from the engine ECU.
ECU Protect	The module received a protect fault condition from the engine ECU.
ECU Red	The module received a red fault condition from the engine ECU.

Continued over page...

Fault	Description
Electrical Trip Stop Inhibited	The module created an electrical trip alarm due to a fault but the generator is prevented from stopping. This is due to the <i>Reset Electrical Trip Inhibit Engine Stop</i> being enabled. To stop the generator, remove the starting request or press the Stop/Reset Mode  button.
Engine Over Speed IEEE C37.2 - 12 Overspeed Device	The module detected that the engine speed had risen above the <i>Over Speed Pre-Alarm Trip</i> level for the configured delay timer.
Engine Over Speed Delayed IEEE C37.2 - 12 Overspeed Device	The module detected that the engine speed had risen above the <i>Over Speed Trip</i> level but was below the <i>Over Speed Overshoot Trip</i> for the configured <i>Overshoot Delay</i> timer during starting.
Engine Under Speed IEEE C37.2 - 14 Underspeed Device	The module detected that the engine speed had fallen below the <i>Under Speed Pre-Alarm Trip</i> level for the configured delay timer after the <i>Safety On Delay</i> timer had expired.
Exp. Unit Failure	The module detected that communications to one of the DSENet [®] expansion modules had been lost.
Fail to Synchronise	The module failed to synchronise the generator before the <i>Fail to Sync Delay</i> timer had expired. The generator continues to synchronise until it is either achieved or runs out of fuel.
Flexible Sensor A to D High	 NOTE: Due to module configuration the alarm message that appears on the display may be different. For further details of module configuration, refer to DSE Publication: 057-238 DSE8610 MKII Configuration Suite PC Software Manual.
	The module detected that an analogue input value had risen above the <i>Flexible Sensor High Pre-Alarm Trip</i> level.
Flexible Sensor A to D Low	 NOTE: Due to module configuration the alarm message that appears on the display may be different. For further details of module configuration, refer to DSE Publication: 057-238 DSE8610 MKII Configuration Suite PC Software Manual.
	The module detected that an analogue input value had fallen below the <i>Flexible Sensor Low Pre-Alarm Trip</i> level.
Fuel Level High IEEE C37.2 - 71 Liquid Level Switch	The module detected that the engine fuel level had risen the <i>High Fuel Level Pre-Alarm</i> level for the configured delay.
Fuel Level Low IEEE C37.2 - 71 Liquid Level Switch	The module detected that the engine fuel level had fallen below the <i>Low Fuel Level Pre-Alarm</i> level for the configured delay
Fuel Level Low Switch IEEE C37.2 - 71 Liquid Level Switch	The module detected that the engine low fuel level switch had activated.
Fuel Usage IEEE C37.2 – 80 Flow Switch	The module detected that the fuel consumption was more then the configured <i>Running Rate</i> or <i>Stopped Rate</i> .
Gen Earth Fault IEEE C37.2 – 51G or 51N Generator IDMT Earth Fault Relay	 NOTE: For more details, see section entitled Earth Fault IDMT Alarm elsewhere in this document.
	The module detected that the generator earth fault current had risen above the <i>Earth Fault Trip Level</i> for the duration of the IDMT function.
Gen Failed to Open IEEE C37.2 – 52b AC Circuit Breaker Position (Contact Open when Breaker Closed)	The module detected that the generator load switch had failed to open as the <i>Generator Closed Auxiliary</i> input stayed activate for the Generator Fail to Open Delay time after the Open Gen Output activated.

Continued over page...

Fault	Description
Gen Loading Frequency	The module detected that the generator output frequency had not risen above the <i>Generator Loading Frequency</i> setting after the <i>Warming Up</i> timer had expired.
Gen Loading Voltage	The module detected that the generator output voltage had not risen above the <i>Generator Loading Voltage</i> setting after the <i>Warming Up</i> timer had expired.
Gen Over Current IEEE C37.2 – 50 Instantaneous Overcurrent Relay IEEE C37.2 – 51 IDMT Overcurrent Relay	<div style="border: 1px solid black; padding: 5px; margin-bottom: 5px;">  NOTE: For more details, see section entitled Over Current Alarm elsewhere in this document. </div> <p>The module detected that the generator output current had risen above the <i>Generator Over Current Trip</i>.</p>
Gen Over Frequency IEEE C37.2 – 81 Frequency Relay	The module detected that the generator output frequency had risen above the <i>Over Frequency Pre-Alarm Trip</i> level for the configured delay timer.
Gen Over Frequency Delayed IEEE C37.2 – 81 Frequency Relay	The module detected that the generator output frequency had risen above the <i>Over Frequency Trip</i> level but was below the <i>Over Frequency Overshoot Trip</i> for the configured <i>Overshoot Delay</i> timer during starting.
Gen Over Voltage IEEE C37.2 – 59 AC Overvoltage Relay	The module detected that the generator output voltage had risen above the <i>Over Voltage Pre-Alarm Trip</i> level for the configured delay timer.
Gen Reverse Power IEEE C37.2 – 32 Directional Power Relay	The module detected that the generator output kW had fallen below the <i>Reverse Power Trip</i> for the configured delay timer.
Gen Short Circuit IEEE C37.2 – 51 IDMT Short Circuit Relay	<div style="border: 1px solid black; padding: 5px; margin-bottom: 5px;">  NOTE: For more details, see section entitled Short Circuit IDMT Alarm elsewhere in this document. </div> <p>The module detected that the generator output current had risen above the <i>Short Circuit Trip</i> for the duration of the IDMT function.</p>
Gen Under Frequency IEEE C37.2 – 81 Frequency Relay	The module detected that the generator output frequency had fallen below the <i>Under Frequency Pre-Alarm Trip</i> level for the configured delay timer after the <i>Safety On Delay</i> timer had expired.
Gen Under Voltage IEEE C37.2 – 27 AC Undervoltage Relay	The module detected that the generator output voltage had fallen below the <i>Under Voltage Pre-Alarm Trip</i> level for the configured delay timer after the <i>Safety On Delay</i> timer had expired.
HEST Active	The module received a fault condition from the engine ECU alerting that the HEST had activated.
Inlet Temperature	The module detected that the engine's ECU measurement of inlet temperature had risen above the <i>Inlet Temperature Pre-Alarm Trip</i> level.
Insufficient Capacity	The module's governor output has reached its limit whilst attempting to control the generator to produce more kW's whilst in parallel. This indicates a fault with either the governor (including connection error), setting of SW2, or that the engine has reached its maximum capacity.
kW Overload IEEE C37.2 – 32 Directional Power Relay	The module detected that the generator output kW had risen above the <i>Overload Protection Trip</i> for the configured delay timer
Loss Of Excitation	The module detected that the generator output kvar had fallen below the <i>Loss of Excitation Pre-Alarm Trip</i> level.
Loss of Mag-PU	The module detected that the magnetic pick up was not producing a pulse output after the required <i>Crank Disconnect</i> criteria had been met.
Low Coolant Warning	The module detected that the engine coolant temperature had fallen below the <i>Low Coolant Temperature Pre-Alarm Trip</i> level.

Continued over page...

Fault	Description
Maintenance Due	<p>▲ NOTE: Due to module configuration the alarm message that appears on the display may be different. For further details of module configuration, refer to DSE Publication: 057-238 DSE8610 MKII Configuration Suite PC Software Manual.</p> <p>The module detected that one of the configured maintenance alarms is due as its configured maintenance interval has expired.</p>
MSC Alarms Inhibited	The module detected that an input configured for <i>MSC Alarms Inhibit</i> had become active disabling all the MSC alarms.
MSC Data Error	The module detected that data on the MSC link had become corrupt, possibly caused by incorrect wiring or faulty cabling.
MSC Failure	That module detected that the MSC communication failed, most likely caused by it being disconnected.
MSC Too Few Sets	That module detected that the number of modules on the MSC was less then the configured <i>Minimum Modules on MSC Link</i> setting.
Negative Phase Sequence IEEE C37.2 - 46 Phase-Balance Current Relay	The module detected that there was an imbalance of current across the generator phases greater than the <i>Negative Phase Sequence Trip Level</i> percentage setting.
Oil Pressure Low IEEE C37.2 - 63 Pressure Switch	The module detected that the engine oil pressure had fallen below the <i>Low Oil Pressure Pre-Alarm Trip</i> level after the <i>Safety On Delay</i> timer had expired.
Protections Disabled	The module detected that an input configured for Protections Disable became active.
SCR Inducement	The module received a fault condition from the engine ECU alerting about the SCR Inducement.
Water in Fuel	The module received a fault condition from the engine ECU alerting that water in the fuel had been detected.
Wet Stacking	The module detected that the generator output kW had fallen below the <i>Low Load Alarm Trip</i> level for the configured delay timer.

6.4 ELECTRICAL TRIP ALARMS

▲ NOTE: The fault condition must be resolved before the alarm can be reset. If the fault condition remains, it is not possible to reset the alarm (the exception to this is the *Coolant Temp High* alarm and similar *Active From Safety On* alarms, as the coolant temperature could be high with the engine at rest).

Electrical Trip Alarms are latching and stop the Generator but in a controlled manner. On initiation of the electrical trip condition the module de-activates the **Close Gen Output** outputs to remove the load from the generator. Once this has occurred the module starts the *Cooling Timer* and allows the engine to cool off-load before shutting down the engine. To restart the generator the fault must be cleared and the alarm reset.

Example:

1/2	Alarms
Gen Over Current	
Electrical Trip	

In the event of an alarm the LCD jumps to the alarms page and scrolls through all active alarms.

Electrical Trip Alarms are latching alarms and to remove the fault, press the **Stop/Reset Mode**  button on the module.

Fault	Description
2130 ID 1 to 4 Analogue Input E to H High	<div style="border: 1px solid black; padding: 2px; margin-bottom: 5px;"> <p>▲ NOTE: Due to module configuration the alarm message that appears on the display may be different. For further details of module configuration, refer to DSE Publication: <i>057-238 DSE8610 MKII Configuration Suite PC Software Manual</i>.</p> </div> <p>The module detected that an analogue input value of a DSE2130 had risen above the <i>Flexible Sensor High Alarm Trip</i> level.</p>
2130 ID 1 to 4 Analogue Input E to H Low	<div style="border: 1px solid black; padding: 2px; margin-bottom: 5px;"> <p>▲ NOTE: Due to module configuration the alarm message that appears on the display may be different. For further details of module configuration, refer to DSE Publication: <i>057-238 DSE8610 MKII Configuration Suite PC Software Manual</i>.</p> </div> <p>The module detected that an analogue input value of a DSE2130 had fallen below the <i>Flexible Sensor Low Alarm Trip</i> level.</p>

Continued over page...

Fault	Description
2130 ID1 to 4 Digital Input A to H	<p>▲ NOTE: Due to module configuration the alarm message that appears on the display may be different. For further details of module configuration, refer to DSE Publication: <i>057-238 DSE8610 MKII Configuration Suite PC Software Manual</i>.</p> <p>The module detected that a digital input configured to create a fault condition on a DSE2130 expansion module became active and the appropriate LCD message displayed.</p>
2131 ID 1 to 4 Analogue Input A to J High	<p>▲ NOTE: Due to module configuration the alarm message that appears on the display may be different. For further details of module configuration, refer to DSE Publication: <i>057-238 DSE8610 MKII Configuration Suite PC Software Manual</i>.</p> <p>The module detected that an analogue input value of a DSE2131 had risen above the <i>Flexible Sensor High Alarm Trip</i> level.</p>
2131 ID 1 to 4 Analogue Input A to J Low	<p>▲ NOTE: Due to module configuration the alarm message that appears on the display may be different. For further details of module configuration, refer to DSE Publication: <i>057-238 DSE8610 MKII Configuration Suite PC Software Manual</i>.</p> <p>The module detected that an analogue input value of a DSE2131 had fallen below the <i>Flexible Sensor Low Alarm Trip</i> level.</p>
2131 ID1 to 4 Digital Input A to J	<p>▲ NOTE: Due to module configuration the alarm message that appears on the display may be different. For further details of module configuration, refer to DSE Publication: <i>057-238 DSE8610 MKII Configuration Suite PC Software Manual</i>.</p> <p>The module detected that a digital input configured to create a fault condition on a DSE2131 expansion module became active and the appropriate LCD message displayed.</p>
2133 ID 1 to 4 Analogue Input A to H High	<p>▲ NOTE: Due to module configuration the alarm message that appears on the display may be different. For further details of module configuration, refer to DSE Publication: <i>057-238 DSE8610 MKII Configuration Suite PC Software Manual</i>.</p> <p>The module detected that an analogue input value of a DSE2133 had risen above the <i>Flexible Sensor High Alarm Trip</i> level.</p>
2133 ID 1 to 4 Analogue Input A to H Low	<p>▲ NOTE: Due to module configuration the alarm message that appears on the display may be different. For further details of module configuration, refer to DSE Publication: <i>057-238 DSE8610 MKII Configuration Suite PC Software Manual</i>.</p> <p>The module detected that an analogue input value of a DSE2133 had fallen below the <i>Flexible Sensor Low Alarm Trip</i> level.</p>

Continued over page...

Fault	Description
Analogue Input A to D (Digital)	<p>▲ NOTE: Due to module configuration the alarm message that appears on the display may be different. For further details of module configuration, refer to DSE Publication: 057-238 DSE8610 MKII Configuration Suite PC Software Manual.</p> <p>The module detected that an analogue input configured as a digital input to create a fault condition became active and the appropriate LCD message is displayed.</p>
Auto Sense Fail	<p>The module detected that the output voltage of the generator had risen above the <i>Over Voltage During Auto Sensing Trip</i> level during starting whilst attempting to detect which alternative configuration to use.</p>
AVR Maximum Trim Limit	<p>The module's AVR output has reached its limit whilst attempting to control the generator to produce more kvars whilst in parallel. This indicates a fault with either the AVR (including connection error), setting of SW2, or that the alternator has reached its maximum capacity.</p>
Bus Not Live	<p>▲ NOTE: For further details, refer to DSE Publication: 056-047 Out of Sync and Failed to Close Training Document.</p> <p>The module did not detect bus voltage or frequency when the generator's load switch closed on to a dead bus.</p>
Bus Phase Seq Wrong <i>IEEE C37.2 – 47 Phase Sequence Relay</i>	<p>The module detected that the phase rotation of the bus was different to the configured <i>Bus Phase Rotation Alarm</i> setting.</p>
Calibration Fault	<p>The module detected that its internal calibration has failed. The unit must be sent back to DSE to be investigated and repaired. Contact DSE Technical Support for more details.</p>
Combined Mains Decoupling	<p>The module detected that the mains supply failed when the generator was in parallel with it.</p>
Coolant Temp High <i>IEEE C37.2 – 26 Apparatus Thermal Device</i>	<p>The module detected that the engine coolant temperature had risen above the <i>High Coolant Temperature Electrical Trip</i> level after the <i>Safety On Delay</i> timer had expired.</p>
DEF Level Low	<p>The module received a fault condition from the engine ECU alerting about the DEF level.</p>
Digital Input A to L	<p>▲ NOTE: Due to module configuration the alarm message that appears on the display may be different. For further details of module configuration, refer to DSE Publication: 057-238 DSE8610 MKII Configuration Suite PC Software Manual.</p> <p>The module detected that a digital input configured to create a fault condition became active and the appropriate LCD message is displayed.</p>
DPTC Filter	<p>The module received a fault condition from the engine ECU alerting that the DPF/DPTC had activated.</p>
ECU Amber	<p>The module received an amber fault condition from the engine ECU.</p>
ECU Data Fail	<p>The module is configured for CAN operation but has not detected data being sent from the engine's ECU.</p>
ECU Malfunc.	<p>The module received a malfunction fault condition from the engine ECU.</p>
ECU Protect	<p>The module received a protect fault condition from the engine ECU.</p>
ECU Red	<p>The module received a red fault condition from the engine ECU.</p>

Continued over page...

Fault	Description
Engine Under Speed IEEE C37.2 - 14 Underspeed Device	The module detected that the engine speed had fallen below the <i>Under Speed Alarm Trip</i> level for the configured delay timer after the <i>Safety On Delay</i> timer had expired.
Exp. Unit Failure	The module detected that communications to one of the DSENet® expansion modules had been lost.
Fail to Synchronise	The module failed to synchronise the generator before the <i>Fail to Sync Delay</i> timer had expired.
Flexible Sensor A to D High	<p>NOTE: Due to module configuration the alarm message that appears on the display may be different. For further details of module configuration, refer to DSE Publication: <i>057-238 DSE8610 MKII Configuration Suite PC Software Manual</i>.</p>
	The module detected that an analogue input value had risen above the <i>Flexible Sensor High Alarm Trip</i> level.
Flexible Sensor A to D Low	<p>NOTE: Due to module configuration the alarm message that appears on the display may be different. For further details of module configuration, refer to DSE Publication: <i>057-238 DSE8610 MKII Configuration Suite PC Software Manual</i>.</p>
	The module detected that an analogue input value had fallen below the <i>Flexible Sensor Low Alarm Trip</i> level.
Fuel Level High IEEE C37.2 - 71 Liquid Level Switch	The module detected that the engine fuel level had risen the <i>High Fuel Level Alarm</i> level for the configured delay.
Fuel Level Low IEEE C37.2 - 71 Liquid Level Switch	The module detected that the engine fuel level had fallen below the <i>Low Fuel Level Alarm</i> level for the configured delay
Fuel Level Low Switch IEEE C37.2 - 71 Liquid Level Switch	The module detected that the engine low fuel level switch had activated.
Fuel Usage IEEE C37.2 - 80 Flow Switch	The module detected that the fuel consumption was more then the configured Running Rate or Stopped Rate.
Gen Earth Fault IEEE C37.2 - 51G or 51N Generator IDMT Earth Fault Relay	<p>NOTE: For more details, see section entitled Earth Fault IDMT Alarm elsewhere in this document.</p>
	The module detected that the generator earth fault current had risen above the <i>Earth Fault Trip Level</i> for the duration of the IDMT function.
Gen Failed to Close IEEE C37.2 - 52b AC Circuit Breaker Position (Contact Open when Breaker Closed)	The module detected that the generator load switch had failed to close as the <i>Generator Closed Auxiliary</i> input did not activate within the <i>Generator Fail to Close Delay</i> time after the <i>Close Gen Output</i> activated.
Gen Loading Frequency	The module detected that the generator output frequency had not risen above the Generator Loading Frequency setting after the Warming Up timer had expired.
Gen Loading Voltage	The module detected that the generator output voltage had not risen above the Generator Loading Voltage setting after the Warming Up timer had expired.
Gen Over Current IEEE C37.2 - 51 IDMT Overcurrent Relay	<p>NOTE: For more details, see section entitled Over Current Alarm elsewhere in this document.</p>
	The module detected that the generator output current had risen above the Generator Over Current Trip for the duration of the IDMT function.

Continued over page...

Protections

Fault	Description
Gen Phase Seq Wrong IEEE C37.2 – 47 Phase Sequence Relay	The module detected that the phase rotation of the generator was different to the configured Generator Phase Rotation Alarm setting.
Gen Reverse Power IEEE C37.2 – 32 Directional Power Relay	The module detected that the generator output kW had fallen below the <i>Reverse Power Trip</i> for the configured delay timer.
Gen Short Circuit IEEE C37.2 – 51 IDMT Short Circuit Relay	▲ NOTE: For more details, see section entitled <i>Short Circuit IDMT Alarm</i> elsewhere in this document.
	The module detected that the generator output current had risen above the <i>Short Circuit Trip</i> for the duration of the IDMT function.
Inlet Temperature	The module detected that the engine's ECU measurement of inlet temperature had risen above the <i>Inlet Temperature Alarm Trip</i> level.
Insufficient Capacity	The module's governor output has reached its limit whilst attempting to control the generator to produce more kW's whilst in parallel. This indicates a fault with either the governor (including connection error), setting of SW2, or that the engine has reached its maximum capacity.
kW Overload IEEE C37.2 – 32 Directional Power Relay	The module detected that the generator output kW had risen above the Overload Protection Trip for the configured delay timer.
Loss of Excitation	The module detected that the generator output kvar had fallen below the <i>Loss of Excitation Alarm Trip</i> level for the configured delay.
Loss of Mag-PU	The module detected that the magnetic pick up was not producing a pulse output after the required Crank Disconnect criteria had been met.
Mains Decoupling OF	The module detected that the mains frequency had risen above the <i>Mains Decoupling Over Frequency Trip</i> level when the generator was in parallel with the mains.
Mains Decoupling OV	The module detected that the mains voltage had risen above the <i>Mains Decoupling Over Voltage Trip</i> level when the generator was in parallel with the mains.
Mains Decoupling UF	The module detected that the mains frequency had fallen below the <i>Mains Decoupling Under Frequency Trip</i> level when the generator was in parallel with the mains.
Mains Decoupling UV	The module detected that the mains voltage had risen above the <i>Mains Decoupling Under Voltage Trip</i> level when the generator was in parallel with the mains.
Mains ROCOF	The module detected that the mains frequency had changed at a rate larger then the <i>Mains ROCOF Alarm Trip</i> level when the generator was in parallel with the mains.
Mains Vector Shift	The module detected that the mains voltage waveform's vector had shifted more then the <i>Mains Vector Shift Alarm Trip</i> level when the generator was in parallel with the mains.
Maintenance Due	▲ NOTE: Due to module configuration the alarm message that appears on the display may be different. For further details of module configuration, refer to DSE Publication: 057-238 DSE8610 MKII Configuration Suite PC Software Manual.
	The module detected that one of the configured maintenance alarms is due as its configured maintenance interval has expired.
MSC Failure	That module detected that the MSC communication failed, most likely caused by it being disconnected.
MSC ID Error	The module detected that another module on the MSC link had the same <i>GenSet MSC ID</i> configured.

Continued over page...

Protections

Fault	Description
MSC Old Version Unit	The module detected that another module on the MSC link was incompatible. Check all the module firmware version numbers (under <i>About Application Number</i> on the modules' displays) and ensure all are the latest version firmware. Use the DSE Configuration Suite Software to upgrade the firmware (<i>Tools Update Firmware</i>) of the older modules.
MSC Too Few Sets	That module detected that the number of modules on the MSC was less then the configured <i>Minimum Modules on MSC Link</i> setting.
Negative Phase Sequence IEEE C37.2 - 46 Phase-Balance Current Relay	The module detected that there was an imbalance of current across the generator phases greater than the <i>Negative Phase Sequence Trip Level</i> percentage setting.
Out Of Sync	 NOTE: For further details, refer to DSE Publication: 056-047 Out of Sync and Failed to Close Training Document.
	The module did not detected that the generator and bus voltage have drifted out of sync. This is caused by some form of external logic tripping open the generator load switch without it informing the DSE module.
SCR Inducement	The module received a fault condition from the engine ECU alerting about the SCR Inducement.
Water in Fuel	The module received a fault condition from the engine ECU alerting that water in the fuel had been detected.

6.5 SHUTDOWN ALARMS

▲ NOTE: The fault condition must be resolved before the alarm can be reset. If the fault condition remains, it is not possible to reset the alarm (the exception to this is the *Oil Pressure Low* alarm and similar *Active From Safety On* alarms, as the oil pressure is low with the engine at rest).

Shutdown Alarms are latching and immediately stop the Generator. On initiation of the shutdown condition the module de-activates the **Close Gen Output** outputs to remove the load from the generator. Once this has occurred, the module shuts the generator set down immediately to prevent further damage. To restart the generator the fault must be cleared and the alarm reset.

Example:

1/2	Alarm
Oil Pressure Low	
Shutdown	

In the event of an alarm the LCD jumps to the alarms page and scrolls through all active alarms.

Shutdown Alarms are latching alarms and to remove the fault, press the **Stop/Reset Mode**  button on the module.

Fault	Description
2130 ID 1 to 4 Analogue Input E to H High	<div style="border: 1px solid black; padding: 2px; margin-bottom: 5px;"> <p>▲ NOTE: Due to module configuration the alarm message that appears on the display may be different. For further details of module configuration, refer to DSE Publication: <i>057-238 DSE8610 MKII Configuration Suite PC Software Manual</i>.</p> </div> <p>The module detected that an analogue input value of a DSE2130 had risen above the <i>Flexible Sensor High Alarm Trip</i> level.</p>
2130 ID 1 to 4 Analogue Input E to H Low	<div style="border: 1px solid black; padding: 2px; margin-bottom: 5px;"> <p>▲ NOTE: Due to module configuration the alarm message that appears on the display may be different. For further details of module configuration, refer to DSE Publication: <i>057-238 DSE8610 MKII Configuration Suite PC Software Manual</i>.</p> </div> <p>The module detected that an analogue input value of a DSE2130 had fallen below the <i>Flexible Sensor Low Alarm Trip</i> level.</p>

Continued over page...

Fault	Description
2130 ID1 to 4 Digital Input A to H	<p>▲ NOTE: Due to module configuration the alarm message that appears on the display may be different. For further details of module configuration, refer to DSE Publication: <i>057-238 DSE8610 MKII Configuration Suite PC Software Manual</i>.</p> <p>The module detected that a digital input configured to create a fault condition on a DSE2130 expansion module became active and the appropriate LCD message displayed.</p>
2131 ID 1 to 4 Analogue Input A to J High	<p>▲ NOTE: Due to module configuration the alarm message that appears on the display may be different. For further details of module configuration, refer to DSE Publication: <i>057-238 DSE8610 MKII Configuration Suite PC Software Manual</i>.</p> <p>The module detected that an analogue input value of a DSE2131 had risen above the <i>Flexible Sensor High Alarm Trip</i> level.</p>
2131 ID 1 to 4 Analogue Input A to J Low	<p>▲ NOTE: Due to module configuration the alarm message that appears on the display may be different. For further details of module configuration, refer to DSE Publication: <i>057-238 DSE8610 MKII Configuration Suite PC Software Manual</i>.</p> <p>The module detected that an analogue input value of a DSE2131 had fallen below the <i>Flexible Sensor Low Alarm Trip</i> level.</p>
2131 ID1 to 4 Digital Input A to J	<p>▲ NOTE: Due to module configuration the alarm message that appears on the display may be different. For further details of module configuration, refer to DSE Publication: <i>057-238 DSE8610 MKII Configuration Suite PC Software Manual</i>.</p> <p>The module detected that a digital input configured to create a fault condition on a DSE2131 expansion module became active and the appropriate LCD message displayed.</p>
2133 ID 1 to 4 Analogue Input A to H High	<p>▲ NOTE: Due to module configuration the alarm message that appears on the display may be different. For further details of module configuration, refer to DSE Publication: <i>057-238 DSE8610 MKII Configuration Suite PC Software Manual</i>.</p> <p>The module detected that an analogue input value of a DSE2133 had risen above the <i>Flexible Sensor High Alarm Trip</i> level.</p>
2133 ID 1 to 4 Analogue Input A to H Low	<p>▲ NOTE: Due to module configuration the alarm message that appears on the display may be different. For further details of module configuration, refer to DSE Publication: <i>057-238 DSE8610 MKII Configuration Suite PC Software Manual</i>.</p> <p>The module detected that an analogue input value of a DSE2133 had fallen below the <i>Flexible Sensor Low Alarm Trip</i> level.</p>



Continued over page...

Fault	Description
Analogue Input A to D (Digital)	<p>▲ NOTE: Due to module configuration the alarm message that appears on the display may be different. For further details of module configuration, refer to DSE Publication: 057-238 DSE8610 MKII Configuration Suite PC Software Manual.</p> <p>The module detected that an analogue input configured as a digital input to create a fault condition became active and the appropriate LCD message is displayed.</p>
Air Flap Closed	The module detected that a digital input configured for <i>Air-Flap Closed Auxiliary</i> became active.
Auto Sense Fail	The module detected that the output voltage of the generator had risen above the <i>Over Voltage During Auto Sensing Trip</i> level during starting whilst attempting to detect which alternative configuration to use.
AVR Maximum Trim Limit	The module's AVR output has reached its limit whilst attempting to control the generator to produce more kvars whilst in parallel. This indicates a fault with either the AVR (including connection error), setting of SW2, or that the alternator has reached its maximum capacity.
Calibration Fault	The module detected that its internal calibration has failed. The unit must be sent back to DSE to be investigated and repaired. Contact DSE Technical Support for more details.
Charge Alt Failure IEEE C37.2 – 27DC Undervoltage Relay	The module detected that the output voltage of the charge alternator had risen above the <i>Charge Alternator Shutdown Trip</i> level for the configured delay timer.
Coolant Temp High IEEE C37.2 – 26 Apparatus Thermal Device	The module detected that the engine coolant temperature had risen above the <i>High Coolant Temperature Shutdown Trip</i> level after the <i>Safety On Delay</i> timer had expired.
Coolant Temp High Switch IEEE C37.2 – 26 Apparatus Thermal Device	The module detected that the high engine coolant temperature switch had activated after the <i>Safety On Delay</i> timer had expired.
DEF Level Low	The module received a fault condition from the engine ECU alerting about the DEF level.
Digital Input A to L	<p>▲ NOTE: Due to module configuration the alarm message that appears on the display may be different. For further details of module configuration, refer to DSE Publication: 057-238 DSE8610 MKII Configuration Suite PC Software Manual.</p> <p>The module detected that a digital input configured to create a fault condition became active and the appropriate LCD message is displayed.</p>
DPTC Filter	The module received a fault condition from the engine ECU alerting that the DPF/DPTC had activated.
ECU Amber	The module received an amber fault condition from the engine ECU.
ECU Data Fail	The module is configured for CAN operation but has not detected data being sent from the engine's ECU.
ECU Malfunc.	The module received a malfunction fault condition from the engine ECU.
ECU Protect	The module received a protect fault condition from the engine ECU.
ECU Red	The module received a red fault condition from the engine ECU.
Emergency Stop IEEE C37.2 - 5 Stopping Device	The module detected that emergency stop button had been pressed removing a positive voltage supply from the emergency stop input terminal. This input is failsafe (normally closed to emergency stop) and immediately stops the generator when the signal is removed.

Continued over page...

Fault	Description
Engine Over Speed IEEE C37.2 - 12 Overspeed Device	The module detected that the engine speed had risen above the <i>Over Speed Alarm Trip</i> level for the configured delay timer.
Engine Over Speed Overshoot IEEE C37.2 - 12 Overspeed Device	The module detected that the engine speed had risen above the <i>Over Speed Overshoot Trip</i> during the configured <i>Overshoot Delay</i> timer whilst starting.
Engine Under Speed IEEE C37.2 - 14 Underspeed Device	The module detected that the engine speed had fallen below the <i>Under Speed Alarm Trip</i> level for the configured delay timer after the <i>Safety On Delay</i> timer had expired.
Exp. Unit Failure	The module detected that communications to one of the DSENet® expansion modules had been lost.
Failed to Start IEEE C37.2 - 48 Incomplete Sequence Relay	The module detected that the generator had failed to start as it did not meet the required Crank Disconnect criteria during the configured number of Crank Attempts.
Failed to Stop IEEE C37.2 - 48 Incomplete Sequence Relay	<p>▲ NOTE: Fail to Stop could indicate a faulty oil pressure sensor. If engine is at rest, check the oil pressure sensor wiring and configuration.</p>
	The module detects a condition that indicates the generator is running when the DSE module has instructed it to stop.
Flexible Sensor A to D High	<p>▲ NOTE: Due to module configuration the alarm message that appears on the display may be different. For further details of module configuration, refer to DSE Publication: 057-238 DSE8610 MKII Configuration Suite PC Software Manual.</p>
	The module detected that an analogue input value had risen above the <i>Flexible Sensor High Alarm Trip</i> level.
Flexible Sensor A to D Low	<p>▲ NOTE: Due to module configuration the alarm message that appears on the display may be different. For further details of module configuration, refer to DSE Publication: 057-238 DSE8610 MKII Configuration Suite PC Software Manual.</p>
	The module detected that an analogue input value had fallen below the <i>Flexible Sensor Low Alarm Trip</i> level.
Fuel Level High IEEE C37.2 - 71 Liquid Level Switch	The module detected that the engine fuel level had risen the <i>High Fuel Level Alarm</i> level for the configured delay.
Fuel Level Low IEEE C37.2 - 71 Liquid Level Switch	The module detected that the engine fuel level had fallen below the <i>Low Fuel Level Alarm</i> level for the configured delay
Fuel Level Low Switch IEEE C37.2 - 71 Liquid Level Switch	The module detected that the engine low fuel level switch had activated.
Fuel Sensor Fault	The module detected that circuit to the engine fuel level sensor had become open circuit.
Fuel Usage IEEE C37.2 - 80 Flow Switch	The module detected that the fuel consumption was more then the configured Running Rate or Stopped Rate.
Gen Earth Fault IEEE C37.2 - 51G or 51N Generator IDMT Earth Fault Relay	<p>▲ NOTE: For more details, see section entitled Earth Fault IDMT Alarm elsewhere in this document.</p>
	The module detected that the generator earth fault current had risen above the <i>Generator Earth Fault Trip Level</i> for the duration of the IDMT function.

Continued over page...

Fault	Description
Gen Loading Frequency	The module detected that the generator output frequency had not risen above the Generator Loading Frequency setting after the Warming Up timer had expired.
Gen Loading Voltage	The module detected that the generator output voltage had not risen above the Generator Loading Voltage setting after the Warming Up timer had expired.
Gen Over Current IEEE C37.2 – 51 IDMT Overcurrent Relay	<div style="border: 2px solid black; padding: 5px; margin-bottom: 5px;">  NOTE: For more details, see section entitled Over Current Alarm elsewhere in this document. </div> <p>The module detected that the generator output current had risen above the <i>Generator Over Current Trip</i> for the duration of the IDMT function.</p>
Gen Over Frequency IEEE C37.2 – 81 Frequency Relay	The module detected that the generator output frequency had risen above the <i>Over Frequency Alarm Trip</i> level for the configured delay timer.
Gen Over Frequency Overshoot IEEE C37.2 – 81 Frequency Relay	The module detected that the generator output frequency had risen above the <i>Over Frequency Overshoot Trip</i> during the configured <i>Overshoot Delay</i> timer whilst starting.
Gen Over Voltage IEEE C37.2 – 59 AC Overvoltage Relay	The module detected that the generator output voltage had risen above the <i>Over Voltage Alarm Trip</i> level for the configured delay timer.
Gen Phase Seq Wrong IEEE C37.2 – 47 Phase Sequence Relay	The module detected that the phase rotation of the generator was different to the configured <i>Generator Phase Rotation Alarm</i> setting.
Gen Reverse Power IEEE C37.2 – 32 Directional Power Relay	The module detected that the generator output kW had fallen below the <i>Reverse Power Trip</i> for the configured delay timer.
Gen Short Circuit IEEE C37.2 – 51 IDMT Short Circuit Relay	<div style="border: 2px solid black; padding: 5px; margin-bottom: 5px;">  NOTE: For more details, see section entitled Short Circuit IDMT Alarm elsewhere in this document. </div> <p>The module detected that the generator output current had risen above the <i>Short Circuit Trip</i> for the duration of the IDMT function.</p>
Gen Under Frequency IEEE C37.2 – 81 Frequency Relay	The module detected that the generator output frequency had fallen below the <i>Under Frequency Alarm Trip</i> level for the configured delay timer after the <i>Safety On Delay</i> timer had expired.
Gen Under Voltage IEEE C37.2 – 27 AC Undervoltage Relay	The module detected that the generator output voltage had fallen below the <i>Under Voltage Alarm Trip</i> level for the configured delay timer after the <i>Safety On Delay</i> timer had expired.
Inlet Temperature	The module detected that the engine's ECU measurement of inlet temperature had risen above the <i>Inlet Temperature Alarm Trip</i> level.
Insufficient Capacity	The module's governor output has reached its limit whilst attempting to control the generator to produce more kW's whilst in parallel. This indicates a fault with either the governor (including connection error), setting of SW2, or that the engine has reached its maximum capacity.
kW Overload IEEE C37.2 – 32 Directional Power Relay	The module detected that the generator output kW had risen above the Overload Protection Trip for the configured delay timer.
Loss of Excitation	The module detected that the generator output kvar had fallen below the <i>Loss of Excitation Alarm Trip</i> level for the configured delay.
Loss of Mag-PU	The module detected that the magnetic pick up was not producing a pulse output after the required Crank Disconnect criteria had been met.
Mag-PU Fault	The module detected that circuit to the magnetic pick up sensor had become open circuit.

Continued over page...

Fault	Description
Maintenance Due	<p>▲ NOTE: Due to module configuration the alarm message that appears on the display may be different. For further details of module configuration, refer to DSE Publication: <i>057-238 DSE8610 MKII Configuration Suite PC Software Manual</i>.</p> <p>The module detected that one of the configured maintenance alarms is due as its configured maintenance interval has expired.</p>
Negative Phase Sequence IEEE C37.2 - 46 Phase-Balance Current Relay	The module detected that there was an imbalance of current across the generator phases greater than the <i>Negative Phase Sequence Trip Level</i> percentage setting.
Oil Press Sender Fault	The module detected that circuit to the engine oil pressure sensor had become open circuit.
Oil Pressure Low IEEE C37.2 - 63 Pressure Switch	The module detected that the engine oil pressure had fallen below the <i>Low Oil Pressure Shutdown Trip</i> level after the <i>Safety On Delay</i> timer had expired.
Oil Pressure Low Switch IEEE C37.2 - 63 Pressure Switch	The module detected that the low oil pressure switch had activated after the <i>Safety On Delay</i> timer had expired.
SCR Inducement	The module received a fault condition from the engine ECU alerting about the SCR Inducement.
Temp. Sender Fault	The module detected that circuit to the engine coolant temperature sensor had become open circuit.
Water in Fuel	The module received a fault condition from the engine ECU alerting that water in the fuel had been detected.

6.6 MAINTENANCE ALARMS

Depending upon module configuration one or more levels of engine maintenance alarm may occur based upon a configurable schedule.

Example 1:

Screen capture from DSE Configuration Suite Software showing the configuration of the Maintenance Alarm for 1, 2 and 3.

When activated, the maintenance alarm can be either a **warning** (set continues to run) or **shutdown** (running the set is not possible).

Resetting the maintenance alarm is normally actioned by the site service engineer after performing the required maintenance.

The method of reset is either by:

Activating an input that has been configured to Maintenance Reset Alarm 1, 2 or 3.

Pressing the maintenance reset button in the DSE Configuration Suite, Maintenance section.

Pressing and holding the **Stop/Reset Mode**  button for 10 seconds on the desired Maintenance Alarm status page. This may be protected by a PIN number.

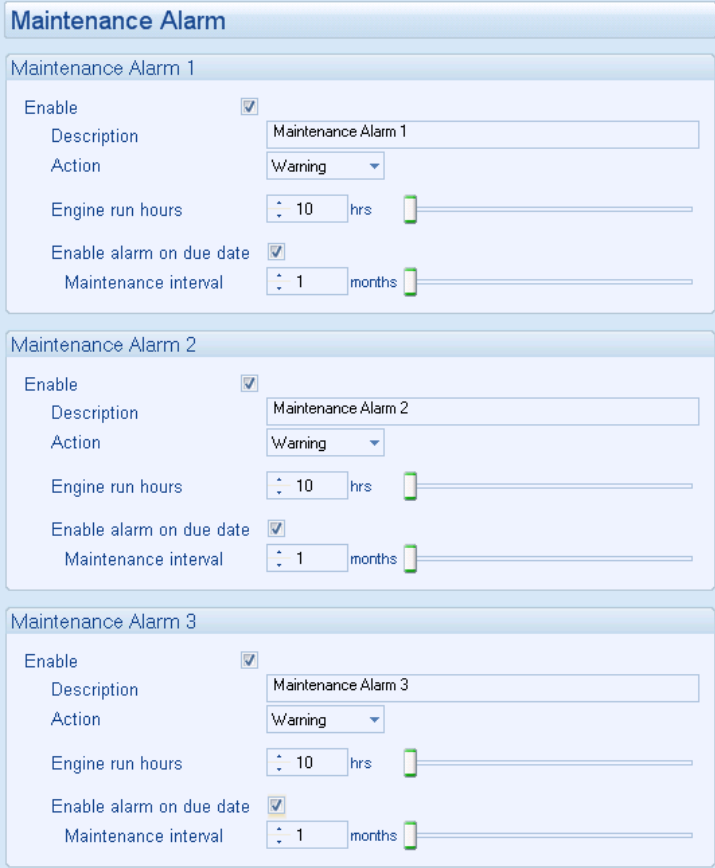

Maintenance Alarm 1

Enable

Description Maintenance Alarm 1

Action Warning

Engine run hours 10 hrs

Enable alarm on due date

Maintenance interval 1 months

Maintenance Alarm 2

Enable

Description Maintenance Alarm 2

Action Warning

Engine run hours 10 hrs

Enable alarm on due date

Maintenance interval 1 months

Maintenance Alarm 3

Enable

Description Maintenance Alarm 3

Action Warning

Engine run hours 10 hrs

Enable alarm on due date

Maintenance interval 1 months

Example 2:

Screen capture from DSE Configuration Suite Software showing the configuration of a digital input for Reset Maintenance Alarm.

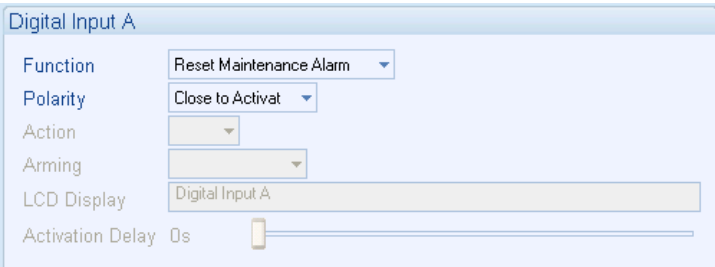

Digital Input A

Function Reset Maintenance Alarm

Polarity Close to Activat

Action

Arming

LCD Display Digital Input A

Activation Delay 0s

Example 3:

Screen capture from DSE Configuration Suite Software showing the Maintenance Alarm Reset 'button' in the DSE Configuration Suite SCADA | MAINTENANCE section.

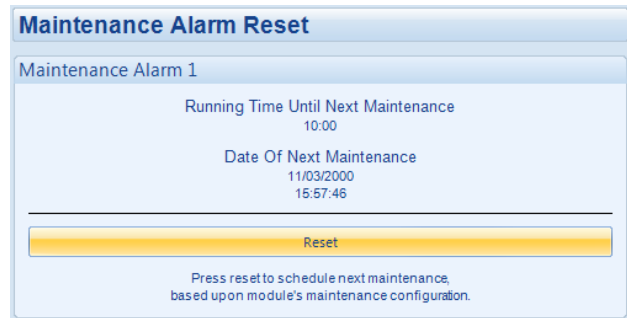

Example 4:

Screen capture from DSE Configuration Suite Software showing the configuration holding stop button to reset the maintenance alarm.



6.7 OVER CURRENT ALARM

The *Over Current Alarm* combines a simple warning trip level with a fully functioning IDMT curve for thermal protection.

6.7.1 IMMEDIATE WARNING

If the *Immediate Warning* is enabled, the controller generates a *warning alarm* as soon as the *Trip* level is reached. The alarm automatically resets once the generator loading current falls below the *Trip* level (unless *All Warnings are latched* is enabled). For further advice, consult the generator supplier.

6.7.2 INVERSE DEFINITE MINIMUM TIME (IDMT) ALARM

If the *Over Current IDMT Alarm* is enabled, the controller begins following the IDMT ‘curve’ when the current on any phase passes the *Trip* setting.

If the *Trip* is surpassed for an excess amount of time, the *IDMT Alarm* triggers (*Shutdown* or *Electrical Trip* as selected in *Action*).

The larger the over circuit fault, the faster the trip. The speed of the trip is dependent upon the fixed formula:

$$T = \frac{t}{\left(\frac{I_A}{I_T} - 1\right)^2}$$

Where:

- T is the tripping time in seconds
- I_A is the actual measured current of the most highly loaded line (L1, L2 or L3)
- I_T is the delayed trip point setting in current
- t is the time multiplier setting and also represents the tripping time in seconds at twice full load (when $I_A/I_T = 2$).

The settings shown in the example below are a screen capture of the DSE factory settings, taken from the DSE Configuration Suite PC Software for a brushless alternator.

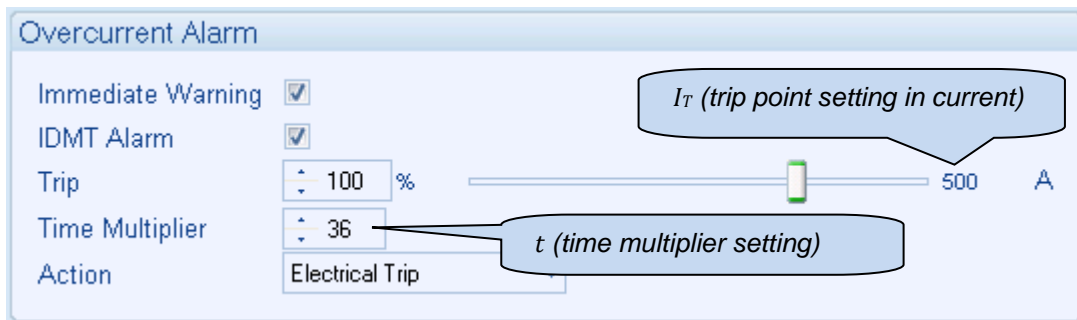

These settings provide for normal running of the generator up to 100% full load. If full load is surpassed, the *Immediate Warning* alarm is triggered and the set continues to run.

The effect of an overload on the generator is that the alternator windings begin to overheat; the aim of the *IDMT Alarm* is to prevent the windings being overload (heated) too much. The amount of time that the alternator can be safely overloaded is governed by how high the overload condition is.

The default settings as shown above allow for an overload of the alternator to the limits of the *Typical Brushless Alternator* whereby 110% overload is permitted for 1 hour or 200% overload is permitted for 36 seconds.

If the alternator load reduces, the controller then follows a cooling curve. This means that a second overload condition may trip soon after the first as the controller knows if the windings have not cooled sufficiently.

For further details on the *Thermal Damage Curve* of your alternator, refer to the alternator manufacturer and generator supplier.

6.7.2.1 CREATING A SPREADSHEET FOR THE OVER CURRENT IDMT CURVE

The formula used:

$$T = \frac{t}{\left(\frac{I_A}{I_T} - 1\right)^2}$$

Where:

- T is the tripping time in seconds
- I_A is the actual measured current of the most highly loaded line (L1, L2 or L3)
- I_T is the delayed trip point setting in current
- t is the time multiplier setting and also represents the tripping time in seconds at twice full load (when $I_A/I_T = 2$).

The equation can be simplified for addition into a spreadsheet. This is useful for ‘trying out’ different values of t (*time multiplier setting*) and viewing the results, without actually testing this on the generator.

	A	B	C	D	E	F
1		1.01	1.02	1.03	1.05	1.06
2	36	360000	90000	40000	14400	10000

I_A/I_T (multiple of the Trip setting from 1.01 to 3.0 in steps of 0.1)

t (time multiplier setting)

T (tripping time in seconds)

The formula for the *Tripping Time* cells is:

```
fx = $A2/POWER((B$1-1),2)
```

Over Current IDMT Alarm Curves

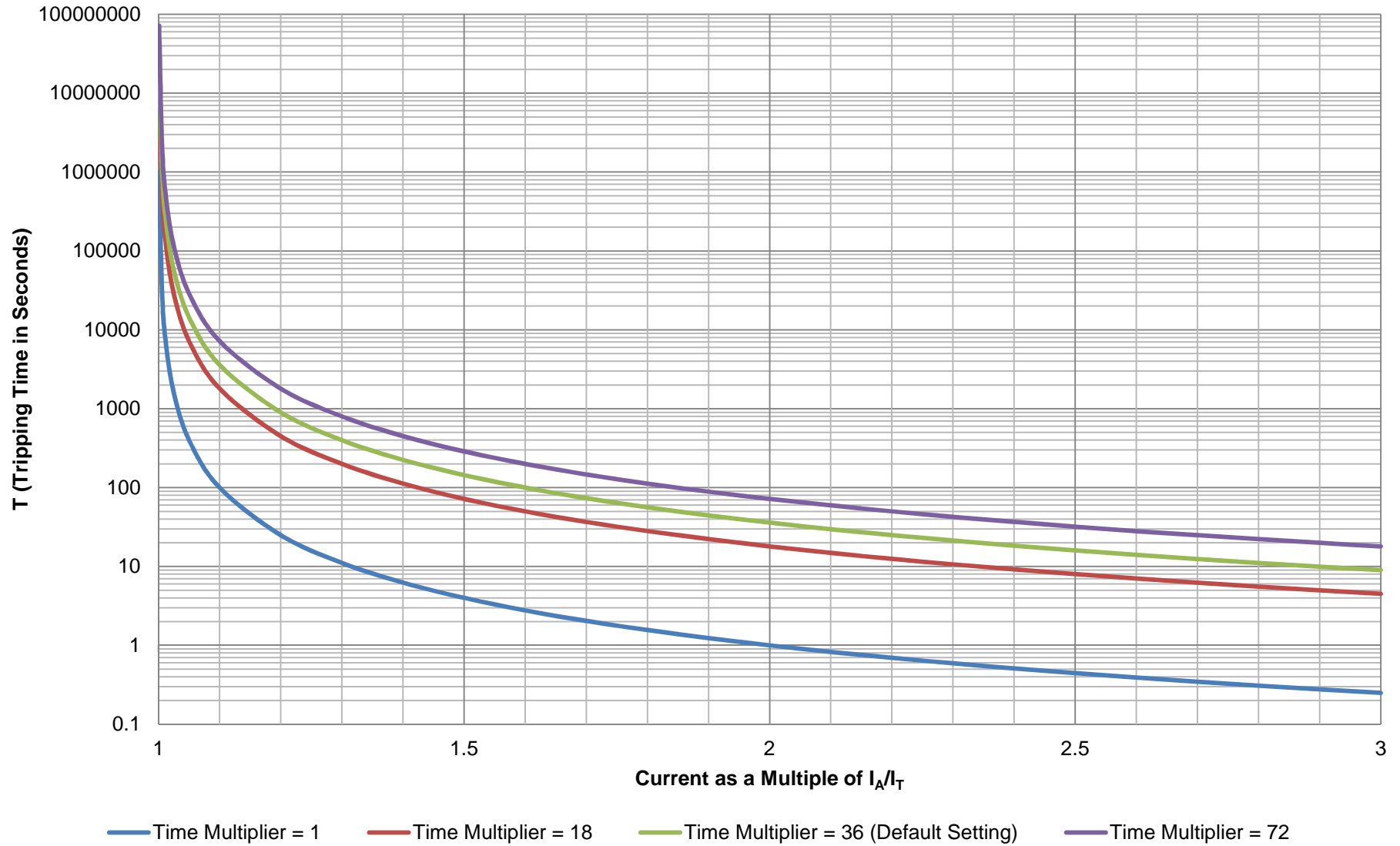

6.8 SHORT CIRCUIT IDMT ALARM

If the *Short Circuit Alarm* is enabled, the controller begins following the IDMT 'curve' when the current on any phase passes the *Trip* setting.

If the *Trip* is surpassed for an excess amount of time, the *IDMT Alarm* triggers (*Shutdown* or *Electrical trip* as selected in *Action*).

The larger the short circuit fault, the faster the trip. The speed of the trip is dependent upon the fixed formula:

$$T = \frac{t \times 0.14}{\left(\left(\frac{I_A}{I_T}\right)^{0.02} - 1\right)}$$

Where:

- T is the tripping time in seconds (accurate to +/- 5% or +/- 50 ms (whichever is the greater))
- I_A is the actual measured current
- I_T is the trip point setting in current
- t is the time multiplier setting

The settings shown in the example below are a screen capture of the DSE factory settings, taken from the DSE Configuration Suite software.

NOTE: Due to large inrush currents from certain loads, such as motors or transformers, the default settings for the *Short Circuit* alarm may need adjusting to compensate.

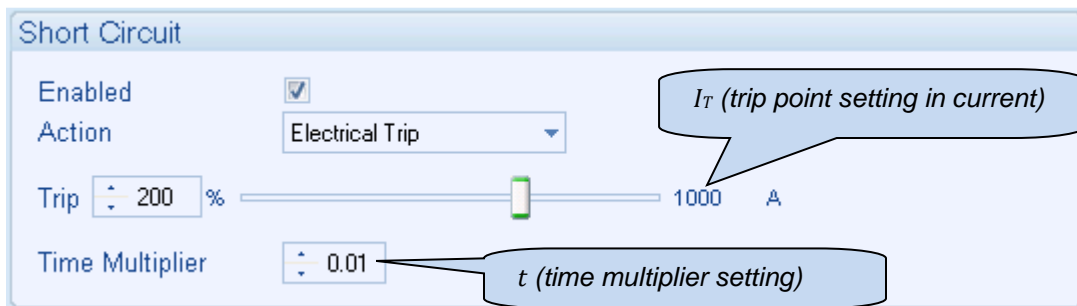

The effect of a short circuit on the generator is that the alternator stator and rotor begin to overheat; the aim of the *IDMT alarm* is to prevent the stator and rotor being overload (heated) too much. The amount of time that the alternator can be safely overloaded is governed by how high the short circuit condition is.

For further details on the *Thermal & Magnetic Damage Curve* of your alternator, refer to the alternator manufacturer and generator supplier.

6.8.1 CREATING A SPREADSHEET FOR THE SHORT CIRCUIT IDMT CURVE

The formula used:

$$T = \frac{t \times 0.14}{\left(\left(\frac{I_A}{I_T}\right)^{0.02} - 1\right)}$$

Where:

T is the tripping time in seconds (accurate to +/- 5% or +/- 50 ms (whichever is the greater))

I_A is the actual measured current

I_T is the trip point setting in current

t is the time multiplier setting

The equation can be simplified for addition into a spreadsheet. This is useful for ‘trying out’ different values of t (*time multiplier setting*) and viewing the results, without actually testing this on the generator.

	A	B	C	D	E	F
1		1.01	1.02	1.03	1.05	1.06
2	0.01	7.034242	25	11.11111	4	2.777778

I_A/I_T (multiple of the Trip setting from 1.01 to 3.0 in steps of 0.1)

t (time multiplier setting)

T (tripping time in seconds)

The formula for the *Tripping Time* cells is:

```
fx =($A2*0.14)/(POWER((B$1),0.02)-1)
```

Short Circuit IDMT Alarm Curves

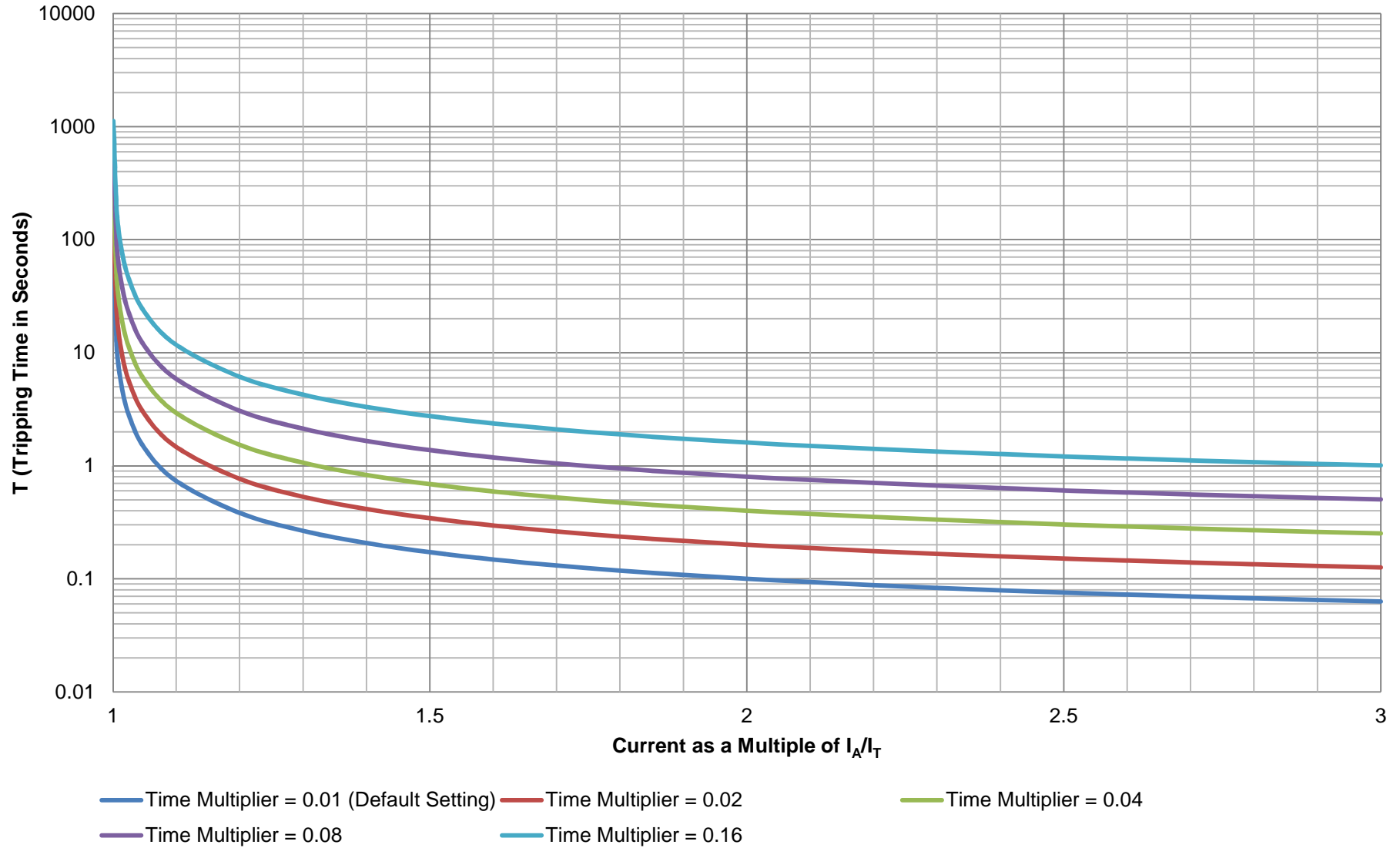

6.9 EARTH FAULT IDMT ALARM

When the module is suitably connected using the 'Earth Fault CT'. The module measures Earth Fault and can optionally be configured to generate an alarm condition (shutdown or electrical trip) when a specified level is surpassed.

If the *Earth Fault Alarm* is enabled, the controller begins following the IDMT 'curve' when the earth fault current passes the *Trip* setting.

If the *Trip* is surpassed for an excess amount of time, the *IDMT Alarm* triggers (*Shutdown* or *Electrical Trip* as selected in *Action*).

The larger the earth fault, the faster the trip. The speed of the trip is dependent upon the fixed formula:

$$T = \frac{t \times 0.14}{\left(\left(\frac{I_A}{I_T}\right)^{0.02} - 1\right)}$$

Where:

- T is the tripping time in seconds (accurate to +/- 5% or +/- 50ms (whichever is the greater))
- I_A is the actual measured current
- I_T is the trip point setting in current
- t is the time multiplier setting

The settings shown in the example below are a screen capture of the DSE factory settings, taken from the DSE Configuration Suite software.

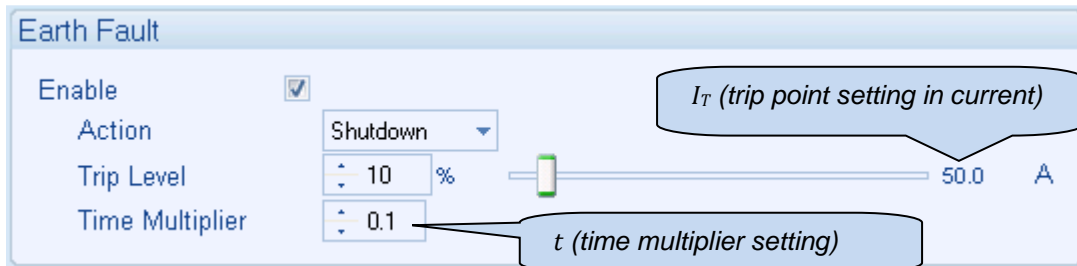

6.9.1 CREATING A SPREADSHEET FOR THE EARTH FAULT IDMT CURVE

The formula used:

$$T = \frac{t \times 0.14}{\left(\left(\frac{I_A}{I_T}\right)^{0.02} - 1\right)}$$

Where:

T is the tripping time in seconds (accurate to +/- 5% or +/- 50 ms (whichever is the greater))

I_A is the actual measured current

I_T is the trip point setting in current

t is the time multiplier setting

The equation can be simplified for addition into a spreadsheet. This is useful for 'trying out' different values of t (*time multiplier setting*) and viewing the results, without actually testing this on the generator.

	A	B	C	D	E	F
1		1.01	1.02	1.03	1.05	1.06
2	0.1	70.34242	250	111.1111	40	27.77778

I_A/I_T (multiple of the Trip setting from 1.01 to 3.0 in steps of 0.1)

t (time multiplier setting)

T (tripping time in seconds)

The formula for the *Tripping Time* cells is:

```
fx =($A2*0.14)/(POWER((B$1),0.02)-1)
```

Earth Fault IDMT Alarm Curves

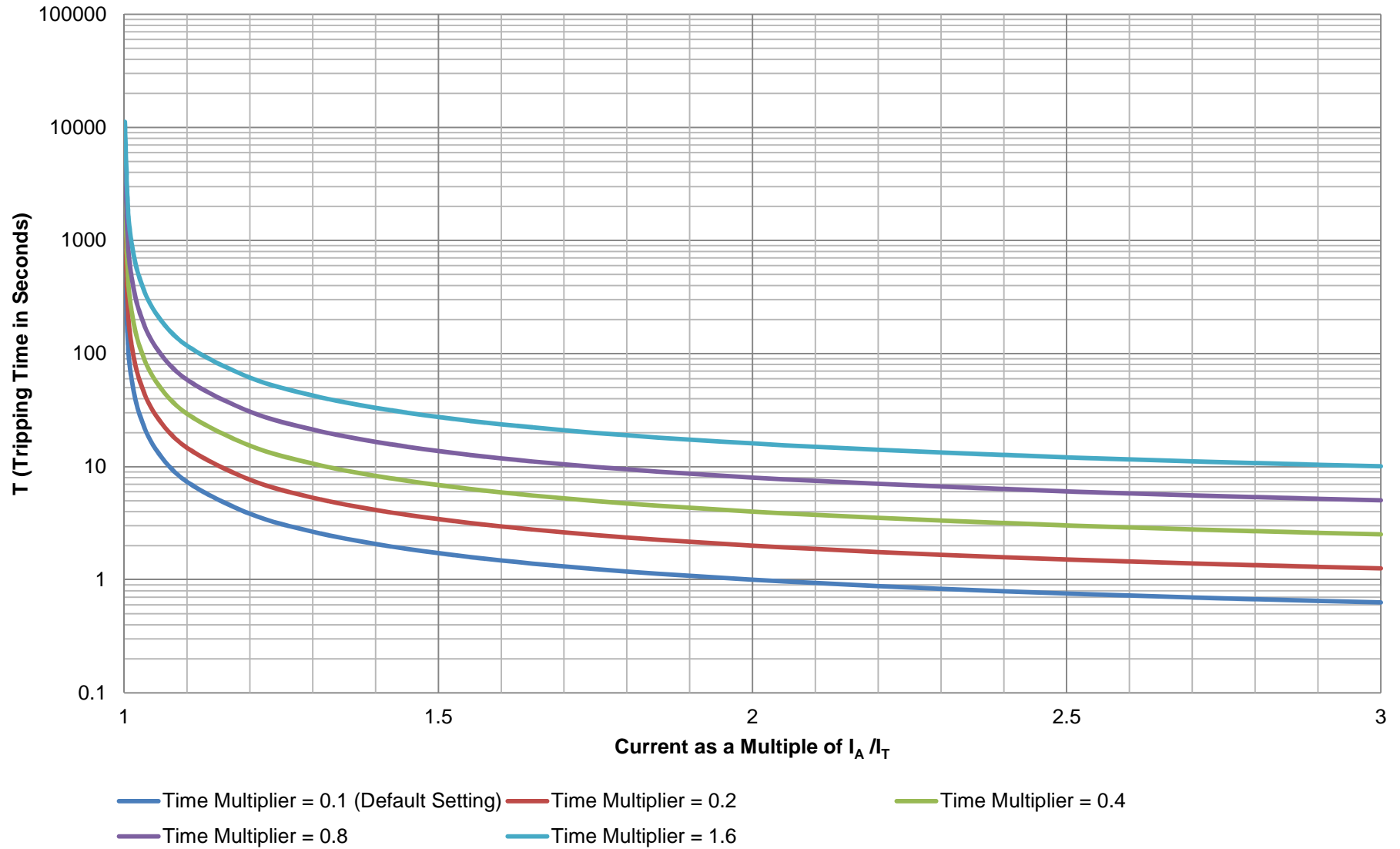

6.10 DEFAULT CURRENT PROTECTION TRIPPING CHARACTERISTICS

The graph on the following page shows the default settings for the IDMT tripping curves for the *Over Current*, *Short Circuit* and *Earth Fault* protections.

The default setting for the *Over Current* alarm allows for an overload of an alternator to the limits of the *Typical Brushless Alternator* whereby 110% overload is permitted for 1 hour or 200% overload is permitted for 36 seconds. In an over current situation the alternator begins to overheat. The aim of the *Over Current IDMT Alarm* is to prevent the windings being overloaded (heated) too much. The amount of time that the alternator can be safely overloaded is governed by how high the overload condition is.

The default setting for the *Short Circuit* alarm allows for an alternator to supply a high current caused by a genuine short circuit or an inrush current of a motor/transformer. Whereby 300% overload is permitted for 0.17 seconds or 600% overload is permitted for 0.06 seconds. In a short circuit situation the alternator begins to overheat to the point the insulation breaks down, potentially causing a fire. The aim of the *Short Circuit IDMT Alarm* is to prevent the insulation from melting due to excessive heat. The amount of time that the alternator can be safely in a short circuit condition is governed by the alternator's construction.

The default setting for the *Earth Fault* alarm allows for an alternator to supply a fault current caused by an imbalanced load, a high impedance short to earth or motor drives. Whereby anything less than 10% is considered normal (caused by imbalanced loads) and permitted, 12% fault current is permitted for 3.83 second or 20% fault current is permitted for 1 second.

DSE Default Configuration of Over Current, Short Circuit & Earth Fault IDMT Alarm Curves

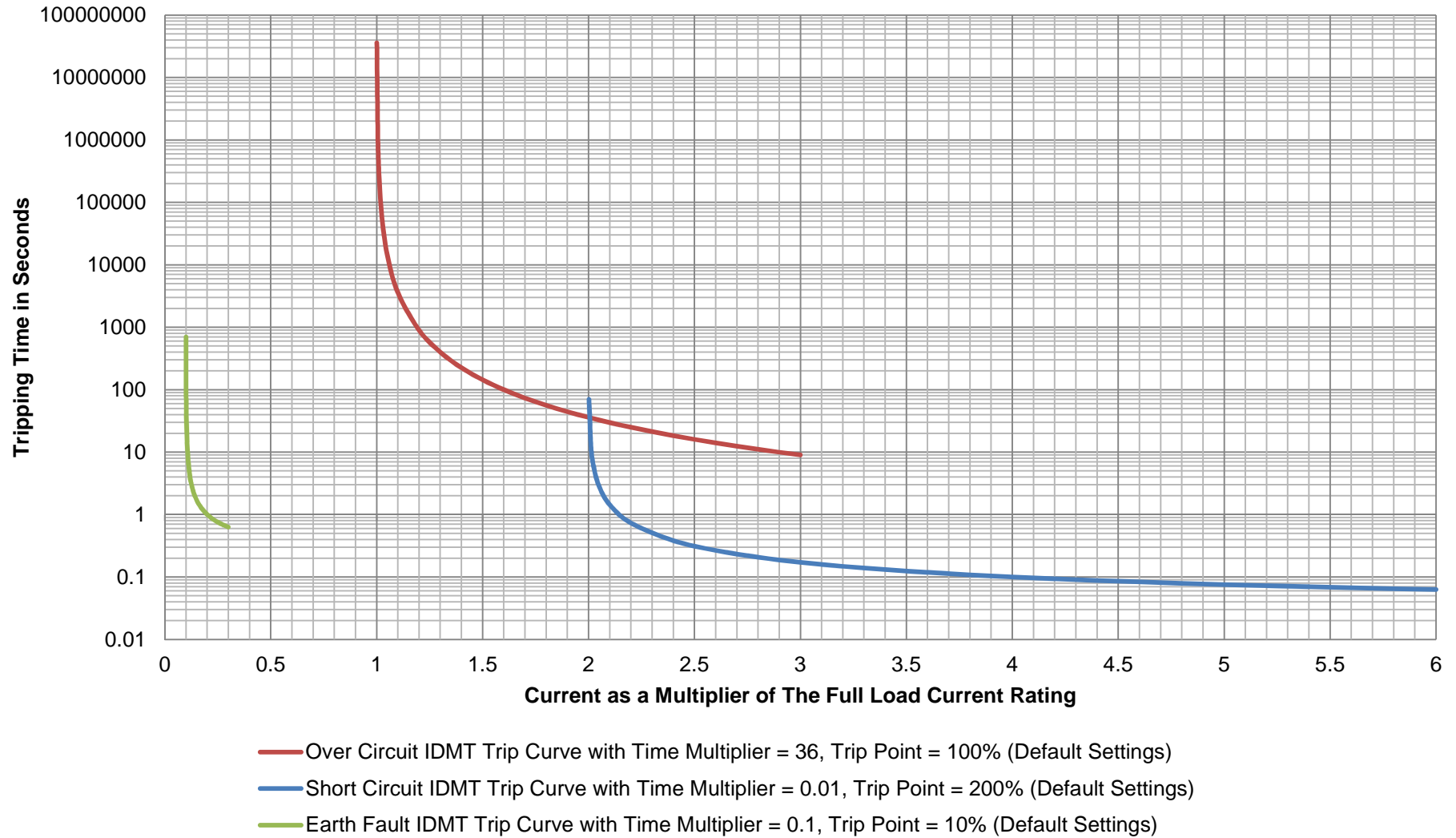

7 FRONT PANEL CONFIGURATION

This configuration mode allows the operator to fully configure the module through its display without the use of the DSE Configuration Suite PC Software.

Use the module's facia buttons to traverse the menu and make value changes to the parameters:

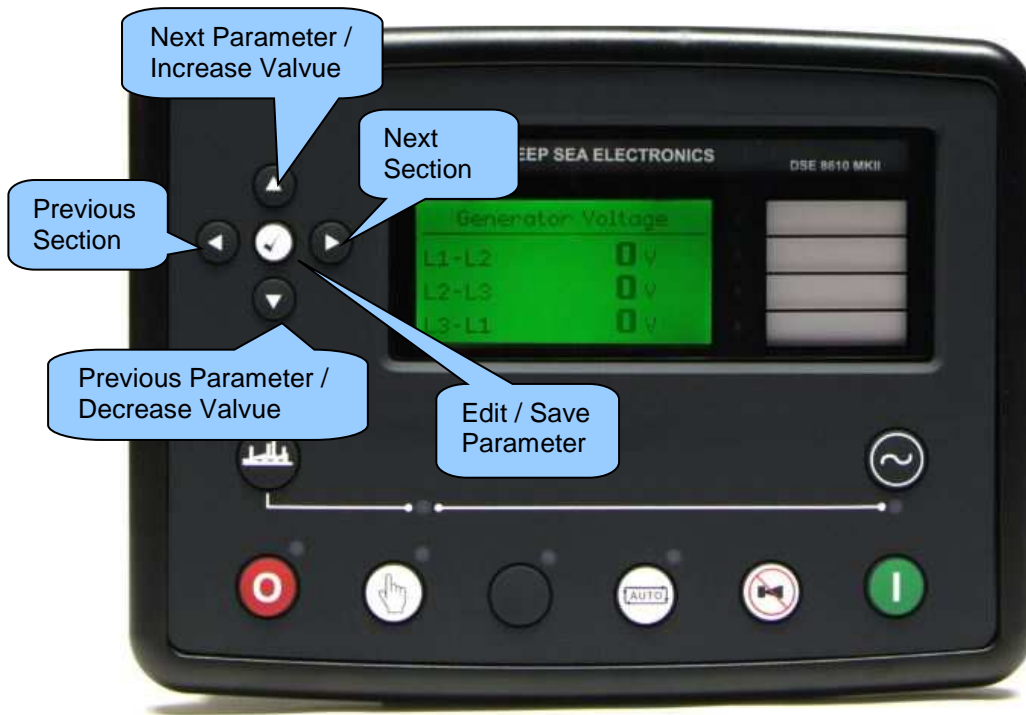

7.1 MAIN CONFIGURATION EDITOR

7.1.1 ACCESSING THE MAIN CONFIGURATION EDITOR

NOTE: More comprehensive module configuration is possible via PC configuration software. For further details of module configuration, refer to DSE Publication: *057- 238 DSE8610 MKII Configuration Suite PC Software Manual*.

- Ensure the engine is at rest and the module by pressing the **Stop/Reset Mode**  button.



- Press the **Stop/Reset Mode**  and **Tick**  buttons together to enter the main configuration editor.

7.1.2 ENTERING PIN

NOTE: The PIN is not set by DSE when the module leaves the factory. If the module has a PIN code set, the generator supplier has entered this. Contact the generator supplier if the code is required. If the code has been 'lost' or 'forgotten', the module must be returned to the DSE factory to have the PIN removed. A charge is made for this procedure. This procedure cannot be performed away from the DSE factory.

NOTE: The PIN is automatically reset when the editor is exited (manually or automatically) to ensure security.

- If a module security PIN has been set, the PIN request is then shown.

- Press the **Tick**  button, the first '#' changes to '0'. Press the **Up** or **Down**  buttons to adjust it to the correct value.



- Press the **Right**  button when the first digit is correctly entered. The digit previously entered now shows as '#' for security.





- Repeat this process for the other digits of the PIN number. Press the **Left**  button to move back to adjust one of the previous digits.

- When the **Tick**  button is pressed after editing the final PIN digit, the PIN is checked for validity. If the number is not correct, the PIN must be re-entered.

- If the PIN has been successfully entered (or the module PIN has not been enabled), the editor is displayed.



7.1.3 EDITING A PARAMETER

 **NOTE:** Pressing and holding the *Menu Navigation*  buttons provides the auto-repeat functionality. Values can be changed quickly by holding the navigation buttons for a prolonged period of time.

- Press the **Right** or **Left**  buttons to cycle to the section to view/change.
- Press the **Up** or **Down**  buttons to select the parameter to view/change within the currently selected section.
- To edit the parameter, press the **Tick**  button to enter edit mode. The parameter begins to flash to indicate editing.
- Press the **Up** or **Down**  buttons to change the parameter to the required value.
- Press the **Tick**  button to save the value. The parameter ceases flashing to indicate that it has been saved.

7.1.4 EXITING THE MAIN CONFIGURATION EDITOR

 **NOTE:** The editor automatically exits after 5 minutes of inactivity to ensure security.



- Press and hold the **Stop/Reset Mode**  button to exit the editor without saving changes.
- Press and hold the **Tick**  button to exit the editor and save the changes.

7.1.5 ADJUSTABLE PARAMETERS

Section	Parameter As Shown On Display	Value	
Display	Contrast	0%	
	Language	English, Other.	
	Current Date and Time	hh:mm	
Engine	Oil Pressure Low Shutdown	0.00 bar	
	Oil Pressure Low Pre Alarm	0.00 bar	
	Coolant Temp high Pre Alarm	0 °C	
	Coolant Temp High Shutdown	0 °C	
	Start Delay Off Load	0 h 0 m 0 s	
	Start Delay Telemetry	0 h 0 m 0 s	
	Engine Pre Heat Timer	0 h 0 m 0 s	
	Engine Crank Duration	0 h 0 m 0 s	
	Engine Crank Rest Time	0 h 0 m 0 s	
	Engine Safety On Delay	0 h 0 m 0 s	
	Engine Smoke Limiting	0 h 0 m 0 s	
	Engine Smoke Limiting Off	0 h 0 m 0 s	
	Engine Warm Up Time	0 h 0 m 0 s	
	Engine Cool Down Time	0 h 0 m 0 s	
	Engine Speed Overshoot Delay	0 h 0 m 0 s	
	Engine Speed Overshoot	0 h 0 m 0 s	
	Engine Failed To Stop Delay	0 h 0 m 0 s	
	Battery Under Voltage Warning	Active, Inactive	
	Battery Under Voltage Warning Delay	0 h 0 m 0 s	
	Battery Under Voltage Warning	0 V	
	Battery Over Voltage Warning	Active, Inactive	
	Battery Over Voltage Warning Delay	0 h 0 m 0 s	
	Battery Over Voltage Warning	0 V	
	Charge Alternator Failure Warning	Active, Inactive	
	Charge Alternator Failure Warning	0 V	
	Charge Alternator Warning Delay	0 h 0 m 0 s	
	Charge Alternator Failure Shutdown	Active, Inactive	
	Specific Gravity	0.80 to 1.00	
	CAN Termination	Active, Inactive	
	Generator	Under Voltage Shutdown	0 V
		Under Voltage Pre-Alarm	0 V
Loading Voltage		0 V	
Nominal Voltage		0 V	
Over Voltage Pre-Alarm		0 V	
Over Voltage Shutdown		0 V	
Under Frequency Shutdown		0 Hz	
Under Frequency Pre-Alarm		0 Hz	
Loading Frequency		0 Hz	
Nominal frequency		0 Hz	
Over Frequency Pre-Alarm		0 Hz	
Over Frequency Shutdown		0 Hz	
Full Load Rating		0 A	
kW Overload Trip		0 %	
Delayed Over current		Active, Inactive	
Gen Over Current Trip		0 %	
AC System		3 Phase 4 Wire	
CT Primary		0 A	
CT Secondary		0 A	
Short Circuit Trip		0 %	
Earth CT Primary		0 A	

Continued over page...

Front Panel Configuration

Section	Parameter As Shown On Display	Value
Generator	Earth Fault Trip	Active, Inactive
	Earth Fault Trip	0 %
	Transient Delay	0 h 0 m 0 s
	Gen Reverse Power Delay	0 h 0 m 0 s
	Full kW Rating	0 kW
	Full kVAr Rating	0 kvar
	Load Ramp Rate	0 %
	Load Level For More Sets	0 %
	Load Level For Less Sets	0 %
	Load Demand Priority	1
	Gen Reverse Power	0 kW
	Insufficient Capacity Delay	0 h 0 m 0 s
	Insufficient Capacity Action	None, Indication, Warning, Shutdown, Electrical Trip
	Reactive Load CTL Mode	None, kvar Share
	Load Parallel Power	0 kW
	Load Power Factor	0 %
	Enable MSC Compatibility	Active, Inactive
Timers	LCD Page Timer	0 h 0 m 0 s
	Scroll Delay	0 h 0 m 0 s
	Engine Pre Heat Timer	0 h 0 m 0 s
	Engine Crank Duration	0 h 0 m 0 s
	Engine Crank Rest Time	0 h 0 m 0 s
	Engine Safety On Delay	0 h 0 m 0 s
	Engine Smoke Limiting	0 h 0 m 0 s
	Engine Smoke Limiting Off	0 h 0 m 0 s
	Engine Warm Up Time	0 h 0 m 0 s
	Engine Cool Down Time	0 h 0 m 0 s
	Engine Speed Overshoot Delay	0 h 0 m 0 s
	Engine Failed To Stop Delay	0 h 0 m 0 s
	Battery Under Voltage Warning Delay	0 h 0 m 0 s
	Battery Over Voltage Warning Delay	0 h 0 m 0 s
	Return Delay	0 h 0 m 0 s
	Generator Transient Delay	0 h 0 m 0 s
Schedule	Scheduler	Active, Inactive
	Schedule On Load	Active, Inactive
	Schedule Period	Weekly, Monthly
	Schedule Time & Date Selection (1-16)	Press  to begin editing then  or  when selecting the different parameters in the scheduler.

7.2 'RUNNING' CONFIGURATION EDITOR

7.2.1 ACCESSING THE 'RUNNING' CONFIGURATION EDITOR

- The *Running Editor* is enterable whilst the generator is running. All protections remain active when the generator is running while the *Running Editor* is entered

- Press and hold the **Tick**  button to access the *Running Editor*.

7.2.2 ENTERING PIN





NOTE: The PIN is not set by DSE when the module leaves the factory. If the module has a PIN code set, this has been affected by your engine supplier who should be contacted if you require the code. If the code has been 'lost' or 'forgotten', the module must be returned to the DSE factory to have the module's code removed. A charge is made for this procedure. NB - This procedure cannot be performed away from the DSE factory.

NOTE: The PIN is automatically reset when the editor is exited (manually or automatically) to ensure security.

Even if a module security PIN has been set, the PIN is not requested whilst entering the *Running Editor*.

7.2.3 EDITING A PARAMETER

NOTE: Pressing and holding the *Menu Navigation*  buttons provides the auto-repeat functionality. Values can be changed quickly by holding the navigation buttons for a prolonged period of time.

- Press the **Right** or **Left**  buttons to cycle to the section to view/change.
- Press the **Up** or **Down**  buttons to select the parameter to view/change within the currently selected section.
- To edit the parameter, press the **Tick**  button to enter edit mode. The parameter begins to flash to indicate editing.
- Press the **Up** or **Down**  buttons to change the parameter to the required value.
- Press the **Tick**  button to save the value. The parameter ceases flashing to indicate that it has been saved.

7.2.4 EXITING THE 'RUNNING' CONFIGURATION EDITOR

 **NOTE: The editor automatically exits after 5 minutes of inactivity to ensure security.**



- Press and hold the **Tick** button to exit the editor and save the changes.

7.2.5 RUNNING EDITOR PARAMETERS

Section	Parameter As Shown On Display	Values
Display	Contrast	0%
	Language	English
Generator	Load Demand Priority	1
	Load Power Factor	0 %
	Load Parallel Power	0 %
	Commissioning Screens	Active, Inactive
	Override Starting Alarms	Active, Inactive
	Voltage Adjust (manual mode only engine running breaker open)	0 %
Frequency Adjust (manual mode only engine running breaker open)	0 %	

8 COMMISSIONING

8.1 BASIC CHECKS





NOTE: If Emergency Stop feature is not required, link the input to the DC Positive.

Before the system is started, it is recommended that the following checks are made:



The unit is adequately cooled and all the wiring to the module is of a standard and rating compatible with the system. Check all mechanical parts are fitted correctly and that all electrical connections (including earths) are sound.

The unit DC supply is fused and connected to the battery and that it is of the correct polarity.

The Emergency Stop input is wired to an external normally closed switch connected to DC positive.

To check the start cycle operation, take appropriate measures to prevent the engine from starting (disable the operation of the fuel solenoid). After a visual inspection to ensure it is safe to proceed, connect the battery supply. Press the **Manual Mode**  button followed by the **Start**  button the unit start sequence commences.

The starter engages and operates for the pre-set crank period. After the starter motor has attempted to start the engine for the pre-set number of attempts, the LCD displays *Failed to Start*. Press the **Stop/Reset Mode**  button to reset the unit.

Restore the engine to operational status (reconnect the fuel solenoid). Press the **Manual Mode**  button followed by the **Start**  button. This time the engine should start and the starter motor should disengage automatically. If not then check that the engine is fully operational (fuel available, etc.) and that the fuel solenoid is operating. The engine should now run up to operating speed. If not, and an alarm is present, check the alarm condition for validity, then check input wiring. The engine should continue to run for an indefinite period. It is possible at this time to view the engine and alternator parameters - refer to the 'Description of Controls' section of this manual.

Press the **Auto Mode**  button, the engine runs for the pre-set cooling down period, then stop. The generator should stay in the standby mode. If it does not, check that the *Remote Start* input is not active.

Initiate an automatic start by supplying the remote start signal (if configured). The start sequence commences and the engine runs up to operational speed. Once the generator is available the delayed load outputs activate, the Generator accepts the load. If not, check the wiring to the delayed load output contactors. Check the Warming timer has timed out.

Remove the remote start signal. The return sequence begins. After the pre-set time, the generator is unloaded. The generator then runs for the pre-set cooling down period, then shutdown into its standby mode.

Set the modules internal clock/calendar to ensure correct operation of the scheduler and event logging functions. For details of this procedure see section entitled *Front Panel Configuration*.

If, despite repeated checking of the connections between the controller and the customer's system, satisfactory operation cannot be achieved, then contact DSE Technical Support Department:

Tel: +44 (0) 1723 890099
Fax: +44 (0) 1723 893303
E-mail: support@deepseapl.com
Website: www.deepseapl.com

8.2 DSE 4 STEPS TO SUCCESSFUL SYNCHRONISING

Synchronising and load sharing is often considered to be a complex subject. In fact, it is very simple when broken down into smaller steps.

After following the *Commissioning* section of this manual, the *DSE 4 Steps* **must** be followed before any parallel operation is attempted.

The following information is a *short form* guide only, intended as a memory jogger once the steps are fully understood.

The full video presentation of the *4 Steps* is available on the DSE website. www.deepseapl.com. Registration on the website is required. This is free of charge, along with all other downloads.

8.2.1 CONTROL

! CAUTION!: Failure to perform the *Control* steps results in poor control over the engine and alternator. This causes long and unstable synchronising as well as unstable kW and kvar load sharing.

NOTE: For further details of module configuration, refer to DSE Publication: 057-238 *DSE8610 MKII Configuration Suite PC Software Manual*.

8.2.1.1 DETERMINING CONNECTIONS AND SETTINGS FOR GOVERNORS

Setting up the Governor (Adjustment of SW1 and SW2)

Before You Start

1. Ensure that the generator is connected to a **DEAD BUS BAR WITH NO LOADS** connected.
2. With the generator breaker open, set the generator to run at the **Nominal Frequency** without the DSE module connected to the Governor. To achieve this you will have to adjust the settings on the governor.
3. Connect the DSE module to the Governor once completed. The DSE controller connects only to the “-” and “IN” terminals and provides the varying DC voltage to simulate the turning of a potentiometer. The Analogue output terminals of the DSE controller are connected as follows. Note that the “+” terminal of the governor is left unconnected.

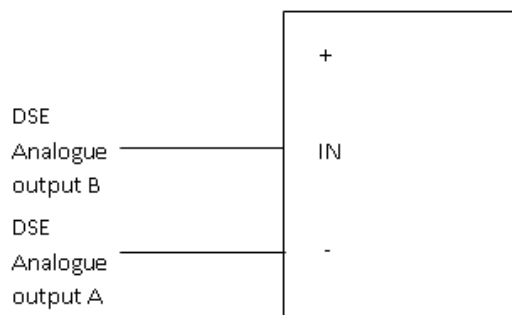

Adjustment of Governor SW1

4. Start the generator and ensure that the breaker is left open.
5. Check the direction of drive by increasing and decreasing SW1. If the frequency increases whilst SW1 is being decreased tick the option 'Output Reversed'. If moving SW1 does not change the frequency, check the wiring to the governor for faults.

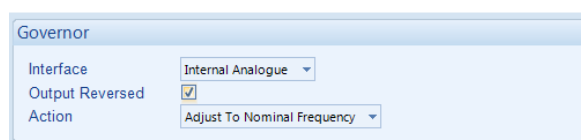

6. Adjust the SW1 setting for the Governor until the generator runs at **Nominal Frequency (50 Hz or 60 Hz)**
7. Stop the generator. SW1 is now complete and needs to be left alone.

Adjustment of Governor SW2

8. Increase the setting of the Nominal Frequency by **2.5 Hz** (52.5 Hz or 62.5 Hz)

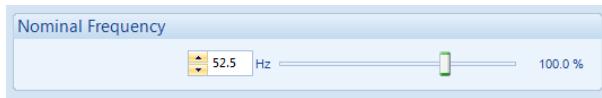

9. Start the generator. With the breaker open the generator will run at setting of SW1 (50 Hz or 60 Hz).
10. Close the generator breaker onto a **DEAD BUS BAR WITH NO LOADS** connected. The generator frequency shall start to increase towards the new Nominal Frequency setting (52.5 Hz or 62.5 Hz) however it may not achieve this.
11. Adjust SW2 to allow the frequency to increase to the new Nominal Frequency (52.5 Hz or 62.5 Hz)
12. Keep adjusting SW2 further to ensure Governor Drive reads within **75% to 85%**, the sign of the drive (+ or - percentage) does not matter.

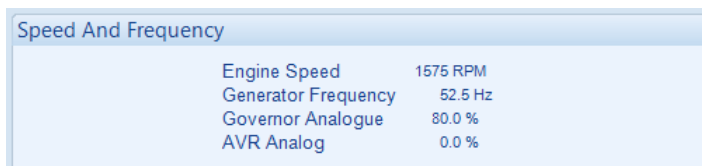

13. Stop the Generator
14. Decrease the setting of the Nominal Frequency by **2.5 Hz** (47.5 Hz or 57.5 Hz)

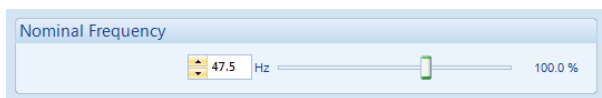

15. Start the generator. With the breaker open the generator will run at setting of SW1 (50 Hz or 60 Hz).
16. Close the generator breaker onto a **DEAD BUS BAR WITH NO LOADS** connected. The generator frequency shall start to decrease towards the new Nominal Frequency (47.5 Hz or 57.5 Hz).
17. SW2 is then adjusted further to ensure Governor Drive reads within **75% to 85%**, the sign of the drive (+ or - percentage) does not matter. Note that any change made to the lower percentage will be the same for the upper percentage. For example, if the lower percentages from 70% to 75%, the upper will increase from 80% to 85%.

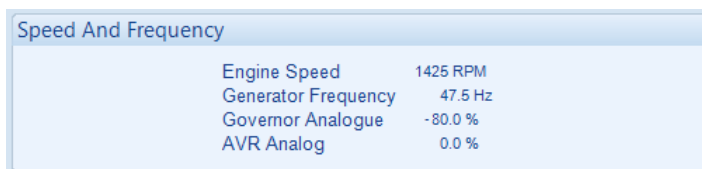

18. Change the setting of the Nominal Frequency back to the actual Nominal Frequency (50 Hz or 60 Hz).

8.2.1.2 DETERMINING CONNECTIONS AND SETTINGS FOR AVRS

NOTE: Determining the settings of SW1 and SW2 for the AVR **MUST** only be done once the setup for SW1 and SW2 for the governor has been complete. Changing engine speed affects the level of voltage produced.

Setting up the AVR (Adjustment of SW1 and SW2)

Before You Start

1. Ensure that the generator is connected to a **DEAD BUS BAR WITH NO LOADS** connected.
2. With the generator breaker open, set the generator to run at the **Nominal Voltage** without the DSE module connected to the AVR. To achieve this you will have to adjust the settings on the AVR.
3. Connect the DSE module to the AVR once completed. The DSE controller connects only to the “-” and “IN” terminals and provides the varying DC voltage to simulate the turning of a potentiometer. The Analogue output terminals of the DSE controller are connected as follows. Note that the “+” terminal of the AVR is left unconnected.

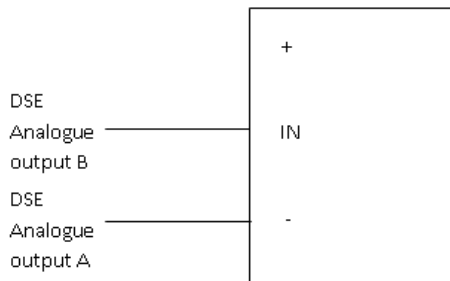

Adjustment of AVR SW1

4. Start the generator and ensure that the breaker is left open.
5. Check the direction of drive by increasing and decreasing SW1. If the voltage increases whilst SW1 is being decreased tick the option 'Output Reversed'. If moving SW1 does not change the voltage, check the wiring to the AVR for faults.

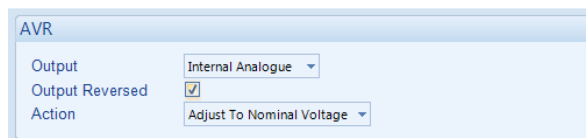

6. Adjust the SW1 setting for the AVR until the generator runs at **Nominal Voltage (230V for example)**.
7. Stop the generator. SW1 is now complete and needs to be left alone.

Adjustment of AVR SW2

8. Increase the setting of the Nominal Voltage by **10%** (230 v to 253 V for example)

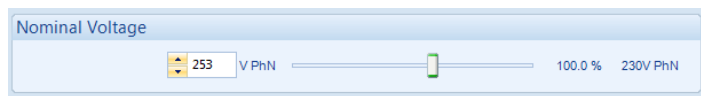

9. Start the generator. With the breaker open the generator will run at setting of SW1 (230V for example).
10. Close the generator breaker onto a **DEAD BUS BAR WITH NO LOADS** connected. The generator voltage shall start to increase towards the new Nominal Voltage setting (253V for example) however it may not achieve this.
11. Adjust SW2 to allow the voltage to increase to the new Nominal Voltage setting (253V for example)
12. Keep adjusting SW2 further to ensure AVR Drive reads within **75% to 85%**, the sign of the drive (+ or - percentage) does not matter.

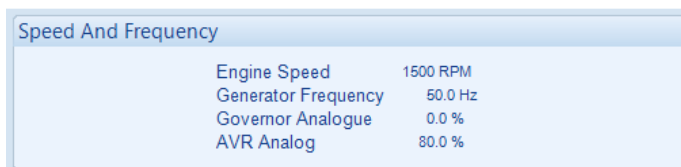

13. Stop the Generator
14. Decrease the setting of the Nominal Voltage by **10%** (207 V for example)

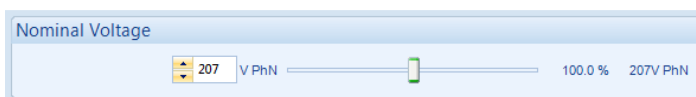

15. Start the generator. With the breaker open the generator will run at setting of SW1 (230V for example).
16. Close the generator breaker onto a **DEAD BUS BAR WITH NO LOADS** connected. The generator voltage shall start to decrease towards the new Nominal Voltage (207 V for example).
17. SW2 is then adjusted further to ensure AVR Drive reads within **75% to 85%**, the sign of the drive (+ or - percentage) does not matter. Note that any change made to the lower percentage will be the same for the upper percentage. For example, if the lower percentages from 70% to 75%, the upper will increase from 80% to 85%.

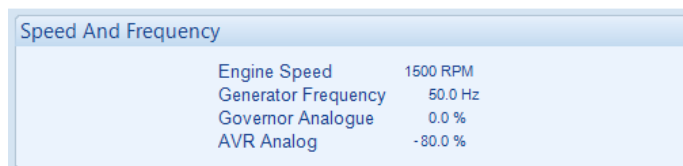

18. Change the setting of the Nominal Voltage back to the actual Nominal Voltage (230 V for example).

8.2.2 METERING

 **CAUTION!** Failure to perform the Metering steps results in incorrect power factor and kW calculations leading to problems with kW and kvar load sharing if not corrected.

 **WARNING!** Do not disconnect this plug when the CTs are carrying current. Disconnection open circuits the secondary of the C.T.'s and dangerous voltages may then develop. Always ensure the CTs are not carrying current and the CTs are short circuit connected before making or breaking connections to the module.

8.2.2.1 CTS ON THE RIGHT PHASE

Check to ensure that the CTs on L1, L2 & L3 are connected to their respective connection on the DSE module.

This is tested by loading the generator with a purely resistive load (around 10% of the generator's size) across the three phases. If the CTs are wired correctly to the DSE module, it displays unity power factor (1.0 pf) across all three phases. If unity power factor is not displayed the CTs have been wired to the wrong phases on the DSE module.

8.2.2.2 CTS IN THE RIGHT DIRECTION

 **NOTE:** Checking that the CTs are on the right phase **MUST** be completed prior to checking if the CTs are in the correct direction. CTs on the wrong phase also cause negative kW's.

Check to ensure that the CTs on L1, L2 & L3 have been mounted for the correct orientation for current flow and that the S1 and S2 have not been swapped over.

This is tested by loading the generator with a purely resistive load (around 10% of the generator's size) across the three phases. If the CTs' S1 and S2 are wired to correctly to the DSE module, it displays positive kW. If negative kW's is displayed the CTs' S1 and S2 have been swapped around.

8.2.3 COMMUNICATIONS

! CAUTION! Failure to perform the Communications steps results in the controllers being unable to communicate to the other DSE controllers leading to problems during load sharing.

NOTE: For further details of module configuration, refer to DSE Publication: 057-238 *DSE8610 MKII Configuration Suite PC Software Manual*.

Check to ensure that all the modules are connected on the MSC link and are communicating correctly.

This is tested by connecting the DSE module to a PC with the DSE Configuration Suite PC Software installed and going to the *SCADA | Generator | Multi-Set* section. The number of *Sets On The Bus* must be the same as the number of DSE8x10s on the MSC link. The number of *Mains Controllers ON The Bus* must be the same as the combined number of DSE8x60s and DSE8x80s on the MSC link.

Multiset	
Bus	
Sets On The Bus	3
Mains Controllers On The Bus	2

If these numbers do not match up there is a fault on the MSC link. To find the module with the fault, connect into each module individually until the *Sets On The Bus* or *Mains Controllers ON The Bus* reports 1.

If these numbers do match up the MSC link is working correctly. A further test to perform is to ensure that the module detects when the MSC link fails. This is tested by removing the MSC link connection from any module on the MSC link. The numbers shown in *SCADA | Generator | Multi-Set* change to reflect the failure and an *MSC Failure* alarm appears on the module's display.

8.2.4 SYNC CHECKS

! CAUTION! Failure to perform the Metering steps results in in serious damage to the system (breakers, bus bars, alternators, engines etc) caused by out of sync closures.

Check to ensure that all the module's sensing cables have been connected to the correct phases and that the generator's load switch has been correctly connected. Failing to perform such tests may lead to the DSE module sensing both sides of the breaker as in sync

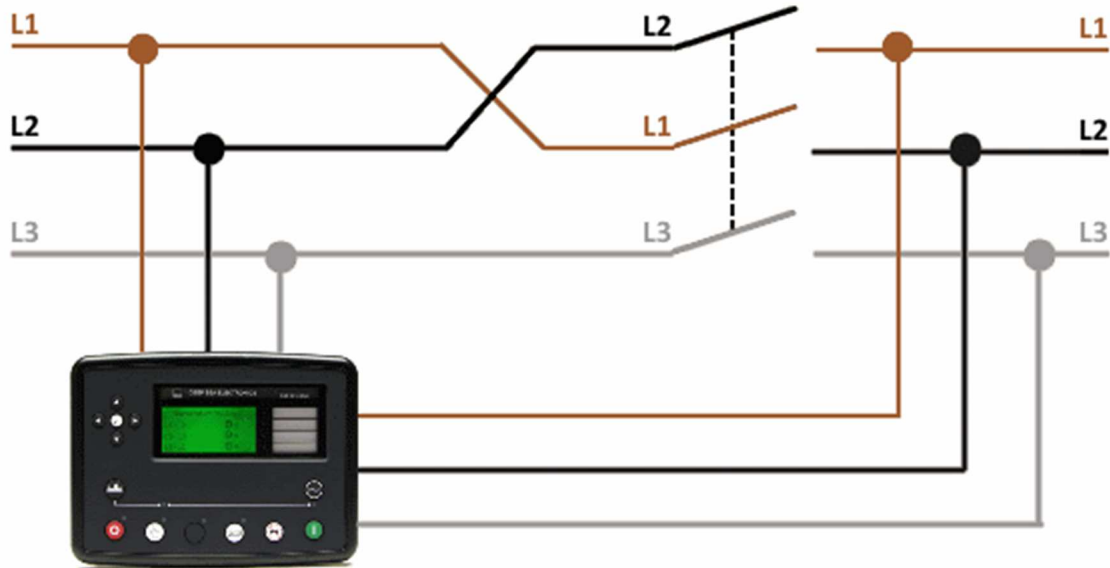

This is tested by starting the generator with the DSE module and ensuring the generator load switch is left open (activate an input configured for *Generator Load Inhibit*). Then the generator common bus is to be made live, this is achieved by starting another generator and closing its load switch. Across the open load switch, connect a voltage meter to measure the AC voltage when the DSE module shows the two supplies in sync.

8.2.4.1 INCORRECTLY WIRED BREAKER

When the DSE module's synchroscope shows the two supplies in sync, if the voltage meter shows a voltage difference the breaker is wired incorrectly. This is shown in the example below.

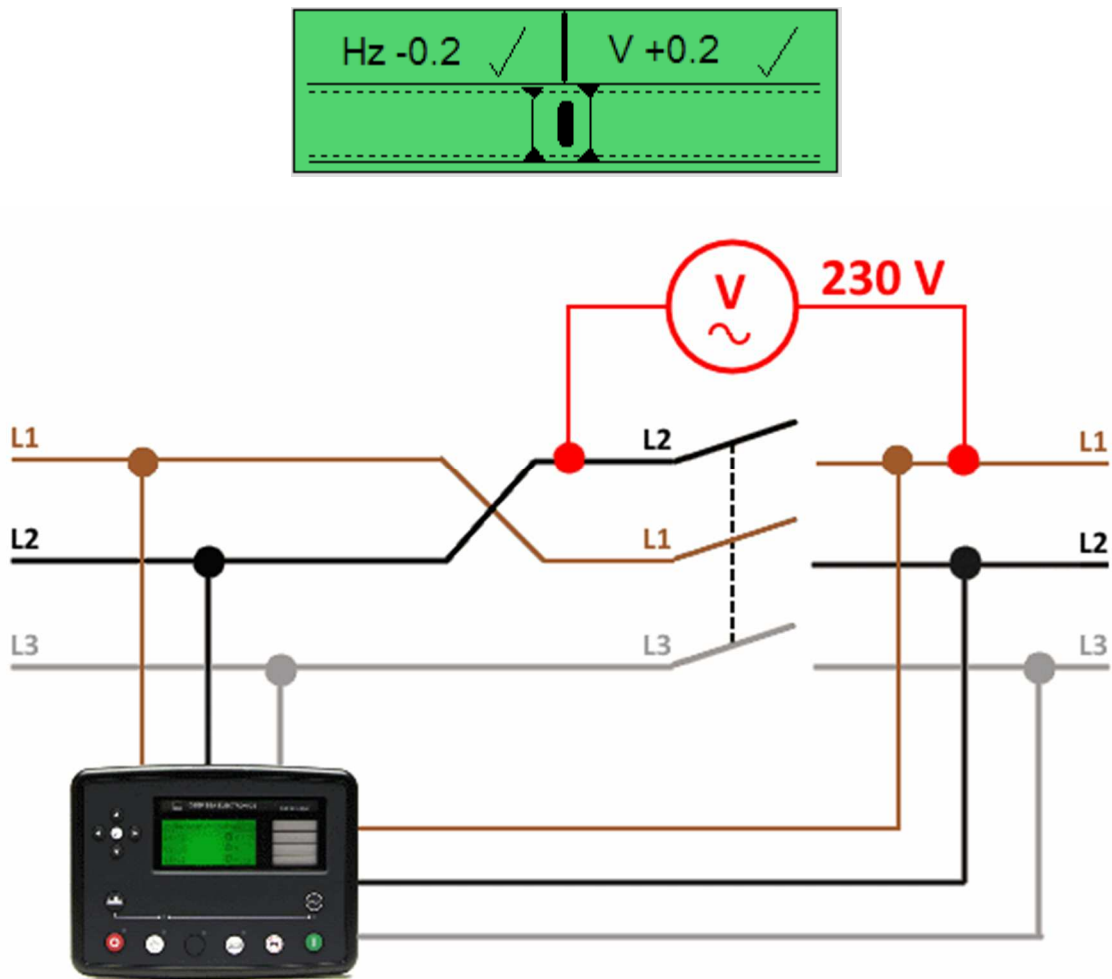

8.2.4.2 CORRECTLY WIRED BREAKER

When the DSE module's synchroscope shows the two supplies in sync, if the voltage meter shows no voltage difference the breaker is wired correctly. This is shown in the example below.

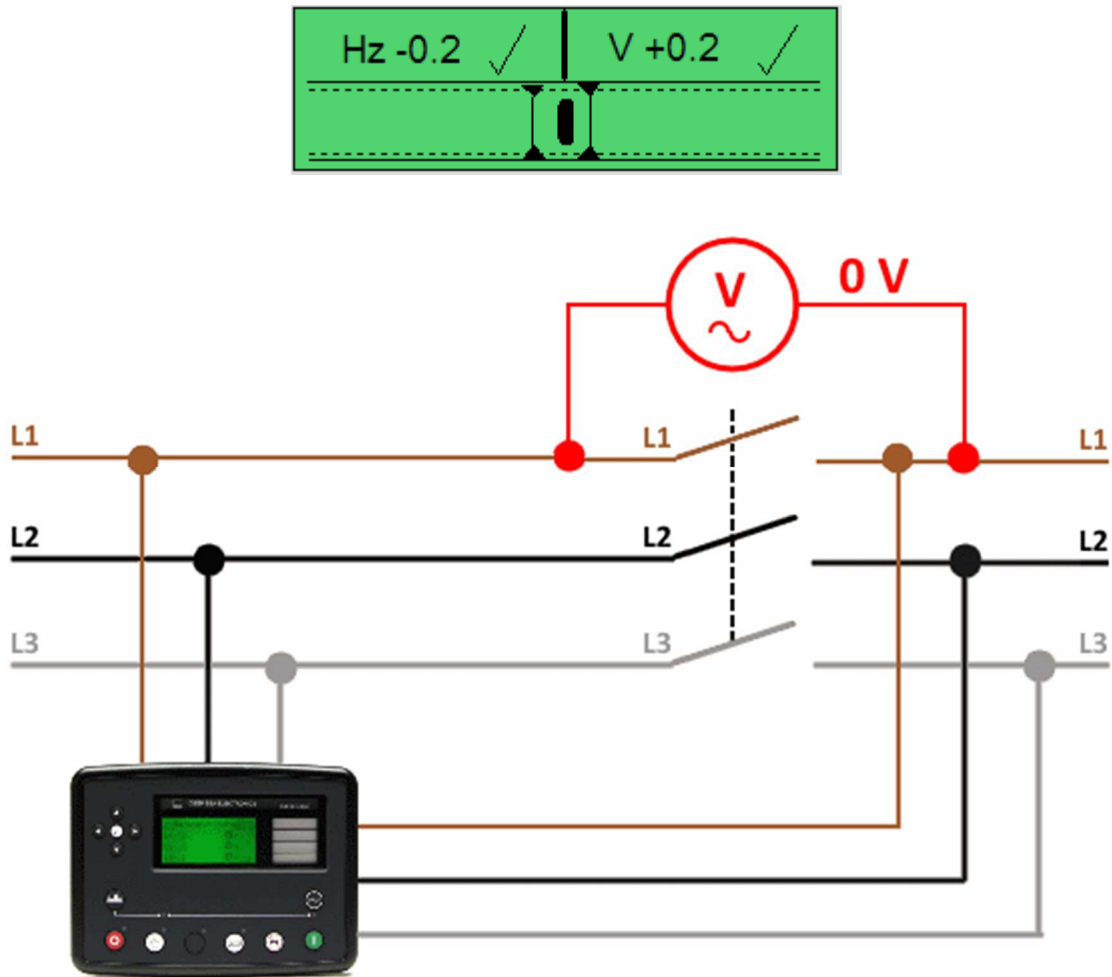

9 FAULT FINDING

 **NOTE:** The below fault finding is provided as a guide check-list only. As the module can be configured to provide a wide range of different features, always refer to the source of the module configuration if in doubt.

9.1 STARTING

Symptom	Possible Remedy
Unit is inoperative	Check the battery and wiring to the unit. Check the DC supply. Check the DC fuse.
Read/Write configuration does not operate	
Unit shuts down	Check DC supply voltage is not above 35 Volts or below 9 Volts Check the operating temperature is not above 70°C. Check the DC fuse.
Fail to Start is activated after pre-set number of attempts to start	Check wiring of fuel solenoid. Check fuel. Check battery supply. Check battery supply is present on the Fuel output of the module. Check the speed-sensing signal is present on the module's inputs. Refer to engine manual.
Continuous starting of generator when in the Auto Mode 	Check that there is no signal present on the "Remote Start" input. Check configured polarity is correct.
Generator fails to start on receipt of Remote Start signal.	Check Start Delay timer has timed out. Check signal is on "Remote Start" input. Confirm correct configuration of input is configured to be used as "Remote Start". Check that the oil pressure switch or sensor is indicating low oil pressure to the controller. Depending upon configuration, the set does not start if oil pressure is not low.
Pre-heat inoperative	Check wiring to engine heater plugs. Check battery supply. Check battery supply is present on the Pre-heat output of module. Check pre-heat configuration is correct.
Starter motor inoperative	Check wiring to starter solenoid. Check battery supply. Check battery supply is present on the Starter output of module. Ensure oil pressure switch or sensor is indicating the "low oil pressure" state to the controller.

9.2 LOADING

Symptom	Possible Remedy
Engine runs but generator does not take load	Check Warm up timer has timed out. Ensure generator load inhibit signal is not present on the module inputs. Check connections to the switching device. Note that the set does not take load in Manual Mode  unless there is an active load signal.
Incorrect reading on Engine gauges	Check engine is operating correctly.
Fail to stop alarm when engine is at rest	Check that sensor is compatible with the module and that the module configuration is suited to the sensor.

9.3 ALARMS

Symptom	Possible Remedy
Oil pressure low fault operates after engine has fired	Check engine oil pressure. Check oil pressure switch/sensor and wiring. Check configured polarity (if applicable) is correct (i.e. Normally Open or Normally Closed) or that sensor is compatible with the module and is correctly configured.
Coolant temp high fault operates after engine has fired.	Check engine temperature. Check switch/sensor and wiring. Check configured polarity (if applicable) is correct (i.e. Normally Open or Normally Closed) or that sensor is compatible with the module.
Shutdown fault operates	Check relevant switch and wiring of fault indicated on LCD display. Check configuration of input.
Electrical Trip fault operates	Check relevant switch and wiring of fault indicated on LCD display. Check configuration of input.
Warning fault operates	Check relevant switch and wiring of fault indicated on LCD display. Check configuration of input.
ECU Amber ECU Red	This indicates a fault condition detected by the engine ECU and transmitted to the DSE controller.
ECU Data Fail	Indicates failure of the CAN data link to the engine ECU. Check all wiring and termination resistors (if required).
Incorrect reading on Engine gauges	Check engine is operating correctly. Check sensor and wiring paying particular attention to the wiring to terminal 14.
Fail to stop alarm when engine is at rest	Check that sensor is compatible with the module and that the module configuration is suited to the sensor.

9.4 COMMUNICATIONS

Symptom	Possible Remedy
ECU Data Fail	Indicates failure of the CAN data link to the engine ECU. Check all wiring and termination resistors (if required).

9.5 INSTRUMENTS

Symptom	Possible Remedy
Inaccurate generator measurements on controller display	<p>Check that the CT primary, CT secondary and VT ratio settings are correct for the application.</p> <p>Check that the CTs are wired correctly with regards to the direction of current flow (p1,p2 and s1,s2) and additionally ensure that CTs are connected to the correct phase (errors occur if CT1 is connected to phase 2).</p> <p>Remember to consider the power factor ($kW = kVA \times \text{powerfactor}$).</p> <p>The controller is true RMS measuring so gives more accurate display when compared with an 'averaging' meter such as an analogue panel meter or some lower specified digital multimeters.</p> <p>Accuracy of the controller is better than 1% of full scale. Generator voltage full scale is 415 V ph-N, accuracy is ± 4.15 V (1 % of 415 V).</p>

9.6 SYNCHRONISING & LOAD SHARING

Symptom	Possible Remedy
Synchronising not available	Check Synchronising is enabled in the configuration suite software Generator, Synchronising section
Generator will not loadshare correctly	Ensure that all the DSE Four Steps to Synchronising have been completed. Check kW Share & kvar Share are enabled, check generator rating is correctly configured in the DSE configuration suite PC Software and check the MSC link is connected correctly.
Synchronising or load sharing is not operating satisfactorily	Follow the DSE "4 Steps To Synchronising" as detailed in the following section.

9.7 MISCELLANEOUS

Symptom	Possible Remedy
Module appears to 'revert' to an earlier configuration	When editing a configuration using the PC software it is vital that the configuration is first 'read' from the controller before editing it. This edited configuration must then be "written" back to the controller for the changes to take effect. When editing a configuration using the fascia editor, be sure to press the Tick  button to save the change before moving to another item or exiting the fascia editor

10 MAINTENANCE, SPARES, REPAIR AND SERVICING

The controller is *Fit and Forget*. As such, there are no user serviceable parts within the controller. In the case of malfunction, you should contact your original equipment manufacturer (OEM).







10.1 PURCHASING ADDITIONAL CONNECTOR PLUGS FROM DSE

If you require additional plugs from DSE, please contact our Sales department using the part numbers below.

10.1.1 PACK OF PLUGS

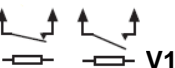
Module Type	Plug Pack Part Number
DSE8610 MKII	007-891

10.1.2 INDIVIDUAL PLUGS

Module Terminal Designation	Plug Description	Part No.
1 to 14  D+ W/L	14 way 5.08 mm	007-428
15 to 22  CAN	8 way 7.62 mm	007-454
23 to 39  ECU MSC GOV AVR	17 way 5.08 mm	007-452
30 to 37  V1	8 way 7.62 mm	007-454
48to 51 V2	4 way 7.62 mm	007-171
52 to 58 	7 way 5.08 mm	007-447
59 to 70 	12 way 5.08 mm	007-109
71 to 76 RS485 Port 1 Port 2	6 way 5.08 mm	007-446
	PC Configuration interface lead (USB type A – USB type B)	016-125

10.2 PURCHASING ADDITIONAL FIXING CLIPS FROM DSE

Item	Description	Part No.
	Module Fixing Clips (Packet of 4)	020-294







10.3 PURCHASING ADDITIONAL SEALING GASKET FROM DSE

Item	Description	Part No.
	Module Silicon Sealing Gasket	020-564

10.4 DSENET® EXPANSION MODULES

NOTE: A maximum of twenty (20) expansion modules can be connected to the DSE8610 MKII DSENet® Port

NOTE: DSENet® utilises an RS485 connection. Using Belden 9841 (or equivalent) cable allows for the expansion cable to be extended to a maximum of 1.2 km. DSE Stock and supply Belden 9841 cable. DSE Part Number 016-030.

Item	Max No. Supported	Description	DSE Part Numbers		
			Model Order Number	Operator Manual	Installation Instructions
	4	Model DSE2130 input module provides additional analogue and digital inputs for use with the controller.	2130-00	055-060	057-082
	4	Model DSE2131 Ratio-metric input expansion module provides additional restive, digital, 0 V to 10 V and 4 mA to 20 mA inputs for use with the controller.	2131-00	055-115	057-139
	4	Model DSE2133 RTD/Thermocouple input expansion module provides additional RTD and thermocouple inputs for use with the controller.	2133-00	055-114	057-140
	4	Model DSE2152 Ratio-metric output expansion module provides additional 0 V to 10 V and 4 mA to 20 mA outputs for use with the controller.	2152-00	055-112	057-141
	10	Model DSE2157 expansion relay module provides eight additional voltage free relays for use with the controller	2157-00	055-061	057-083
	10	Model DSE2548 expansion LED module provides additional LED indications, internal sounder and remote lamp test/alarm mute for use with the controller.	2548-00	057-084	053-032

11 WARRANTY

DSE Provides limited warranty to the equipment purchaser at the point of sale. For full details of any applicable warranty, refer to the original equipment supplier (OEM)

12 DISPOSAL

12.1 WEEE (WASTE ELECTRICAL AND ELECTRONIC EQUIPMENT)

If you use electrical and electronic equipment you must store, collect, treat, recycle and dispose of WEEE separately from your other waste



This Page is Intentionally Blank

This Page is Intentionally Blank